



# Scewo BRO V1.0

---

## User Manual

Publication date 17 October 2023  
Valid as of software version: 23.9.11

**Manufacturer**

Scewo AG  
Technoparkstrasse 7  
8406 Winterthur  
Schweiz

Tel: +41 44 500 86 03  
E-Mail: [info@scewo.ch](mailto:info@scewo.ch)  
Web: [www.scewo.com](http://www.scewo.com)  
UID: CHE-315.209.303

# Table of Contents

- Revision History ..... 7
- 1. Important Information ..... 9
  - 1.1. Product Release ..... 9
  - 1.2. Intended Purpose ..... 9
    - 1.2.1. Key Specifications ..... 10
    - 1.2.2. Indications ..... 10
    - 1.2.3. Contraindications ..... 10
  - 1.3. Technical Support ..... 11
  - 1.4. Warranty Conditions ..... 11
  - 1.5. Liability ..... 11
  - 1.6. Symbols ..... 11
  - 1.7. Obligation to Report Incidents that Have Occurred with the Device ..... 12
  - 1.8. BRO Certificate ..... 12
- 2. Product Description ..... 13
  - 2.1. Overview ..... 13
  - 2.2. Labels ..... 14
    - 2.2.1. Name Plate with Serial Number ..... 14
    - 2.2.2. Use Only After Training and Examination ..... 14
    - 2.2.3. Main Switch and Brake Release ..... 14
    - 2.2.4. Not Permitted for Use as a Seat in a Motorised Vehicle ..... 15
    - 2.2.5. Crushing Hazard ..... 15
  - 2.3. BRO-Backpack and Valuables Pouch ..... 16
  - 2.4. LED Lights ..... 16
  - 2.5. Turn Indicator ..... 17
  - 2.6. Lifting Points ..... 17
- 3. Adapting the Wheelchair to the User ..... 18
  - 3.1. Joystick ..... 18
  - 3.2. Back Support ..... 19
    - 3.2.1. Adjusting the Angle of the Back Support Electrically ..... 19
    - 3.2.2. Folding of the Back Support ..... 19
    - 3.2.3. Removing the Back Support ..... 20
  - 3.3. Arm Supports ..... 20
    - 3.3.1. Dismantling the Arm Support ..... 20
    - 3.3.2. Mechanical Adjustment of the Arm Support Height ..... 21
    - 3.3.3. Mechanical Adjustment of Arm Support Angle ..... 21
    - 3.3.4. Mechanical Adjustment of Arm Support Width ..... 22
    - 3.3.5. Mechanical Adjustment of the Length of the Arm Support (Control Panel Position) ..... 22
    - 3.3.6. Folding the Arm Supports Up and Down ..... 23
  - 3.4. Leg Support ..... 23
    - 3.4.1. Mechanical Adjustment of the Length of the Leg Support ..... 23
    - 3.4.2. Adjusting the Angle of the Leg Support Electrically ..... 24
  - 3.5. Foot Supports ..... 24
    - 3.5.1. Mechanical Adjustment of the Foot Support Angle ..... 24
    - 3.5.2. Folding the Foot Supports Up and Down ..... 25
  - 3.6. Seat ..... 25
    - 3.6.1. Adjusting the Position of the Seat Lift ..... 25
    - 3.6.2. Mechanical Adjustment of the Seat Depth ..... 25
  - 3.7. Seat and Back Cushions (Accessory) ..... 26
    - 3.7.1. Seat Cushion (Accessory) ..... 26
    - 3.7.2. Back Cushion (Accessory) ..... 26
  - 3.8. Head Support (Accessory) ..... 27
    - 3.8.1. Attach/Remove the Head Support ..... 28

- 3.8.2. Adjusting the Head Support ..... 29
- 3.9. Lateral Thigh Supports (Accessory) ..... 29
- 3.10. Magnetic Smartphone Holder "Magic Mount" (Accessory) ..... 30
- 3.11. Cup Holder "Drink Dock" (Accessory) ..... 31
  - 3.11.1. Placing Drinks in the Drink Dock ..... 32
  - 3.11.2. Attach/Remove the Drink Dock ..... 33
  - 3.11.3. Repairing Deformation of Clamps ..... 33
- 4. Control Panel ..... 34
  - 4.1. Overview ..... 35
    - 4.1.1. Battery Level ..... 36
  - 4.2. Open Menu ..... 37
  - 4.3. Select Menu Option ..... 37
  - 4.4. User Interaction Prompts ..... 38
  - 4.5. Warning Indicator ..... 39
  - 4.6. Error Indication ..... 39
  - 4.7. Deactivate/Activate Touchpad ..... 39
  - 4.8. Drive Mode Settings ..... 40
    - 4.8.1. Calibrating the Center of Gravity ..... 40
    - 4.8.2. Braking Behavior Setting ..... 41
    - 4.8.3. Maximum Speed in Drive Mode ..... 42
  - 4.9. Adjusting the Seat Motors Via the Control Panel ..... 44
- 5. Operating the Wheelchair ..... 45
  - 5.1. Powering the Wheelchair On and Off ..... 45
    - 5.1.1. Powering On ..... 45
    - 5.1.2. Powering Off (Standby) ..... 46
    - 5.1.3. Powering Off (Storage and Transport) ..... 46
    - 5.1.4. Reset ..... 47
  - 5.2. Overview of Operating Modes ..... 48
  - 5.3. Park Mode ..... 49
    - 5.3.1. Selecting Park Mode ..... 50
  - 5.4. Elevate Mode (Seat Position) ..... 51
    - 5.4.1. Select Elevate Mode ..... 52
  - 5.5. Drive Mode (Balancing) ..... 53
    - 5.5.1. Activating Drive Mode ..... 55
    - 5.5.2. Restart After a Balancing Error ..... 56
    - 5.5.3. Exiting Drive Mode ..... 57
    - 5.5.4. Driving in Confined Spaces ..... 57
    - 5.5.5. Turns ..... 58
    - 5.5.6. Going over Small Curbs /Thresholds ..... 58
    - 5.5.7. Slopes ..... 60
    - 5.5.8. Driving on Different Surfaces ..... 61
    - 5.5.9. Drive Mode with Low Battery ..... 61
    - 5.5.10. Unexpected Movements of the Wheelchair ..... 62
    - 5.5.11. Emergency Brake ..... 62
    - 5.5.12. Emergency Shutdown ..... 62
  - 5.6. Stair Mode ..... 63
    - 5.6.1. Selecting Stair Mode ..... 66
    - 5.6.2. Climbing Up Stairs ..... 68
    - 5.6.3. Maneuvering Mode ..... 69
    - 5.6.4. Climbing Down Stairs ..... 70
    - 5.6.5. Suitable Stairs ..... 71
    - 5.6.6. Unsuitable Stairs ..... 73
    - 5.6.7. End-of-stair Sensors ..... 76
    - 5.6.8. Premature Detection of the End of Stairs ..... 77
    - 5.6.9. Special Stair Climbing Situations ..... 79

- 5.7. Anti-Tip-System (ATS) ..... 81
- 5.8. Track Mode ..... 83
  - 5.8.1. Selecting Track Mode ..... 83
  - 5.8.2. Driving on Ramps in Track Mode ..... 84
  - 5.8.3. Situations that are not Suited for Track Mode ..... 85
- 5.9. Car Passenger Mode ..... 86
- 5.10. Transporting the Wheelchair ..... 87
  - 5.10.1. Transporting the Wheelchair in the Car ..... 87
  - 5.10.2. Usage and Transport of the Wheelchair on Public Transport ..... 89
  - 5.10.3. Transport of the Wheelchair on an Aircraft ..... 90
- 5.11. Charging the Battery ..... 92
- 5.12. Manual Emergency Operation (Push Mode) ..... 94
  - 5.12.1. Releasing the Main Brake ..... 94
  - 5.12.2. Push Mode on Level Ground ..... 95
  - 5.12.3. Push Mode on Stairs ..... 96
- 5.13. Connecting the App (Authorizing Wi-Fi Connection) ..... 97
- 6. Additional Safety Information ..... 98
  - 6.1. Basic Notes and Instructions ..... 98
  - 6.2. Pelvic Belt ..... 99
  - 6.3. Drive Mode ..... 99
  - 6.4. Additional Devices ..... 99
  - 6.5. Special Situations ..... 100
  - 6.6. Getting On and Off ..... 100
  - 6.7. Environmental Conditions ..... 100
  - 6.8. Transport ..... 101
- 7. Maintenance and Repair ..... 102
  - 7.1. Maintenance ..... 102
  - 7.2. Wheels and Tyres ..... 102
    - 7.2.1. Tyre Pressure ..... 103
  - 7.3. Cleaning ..... 103
    - 7.3.1. Metal Surfaces ..... 103
    - 7.3.2. Plastics ..... 103
    - 7.3.3. Upholstery ..... 104
    - 7.3.4. Disinfection ..... 104
    - 7.3.5. Wheels and Tracks ..... 104
  - 7.4. Replacing the Main Battery ..... 104
  - 7.5. Replacing the Backup Battery ..... 104
  - 7.6. Spare Parts ..... 104
  - 7.7. Disposal and Recycling ..... 105
- 8. Software Updates ..... 106
- 9. Error Messages and Troubleshooting ..... 107
  - 9.1. Malfunctions ..... 107
    - 9.1.1. Rubber Track Fell out of the Guidance System ..... 107
    - 9.1.2. Insufficient Battery Range ..... 108
  - 9.2. Error Messages ..... 108
    - 9.2.1. Error ..... 109
    - 9.2.2. Warnings ..... 111
    - 9.2.3. Information ..... 116
- 10. Technical Specifications ..... 118
- 11. Index ..... 122



## REVISION HISTORY

### Revision History

Revision 1	4 Apr 2023	Maike Neubauer
Neues Layout. Keine inhaltlichen Änderungen		
Revision 2	8 May 2023	Pascal Buholzer
Update für Software Version 23.4.3. Diverse kleinere Vereinfachungen.		
Revision 3	04 Jul 2023	Pascal Buholzer
Getränkehalter und magnetischer Smartphonehalter hinzugefügt. Verbesserung der Verständlichkeit beim Überwinden von Einzelritten, Mindestabständen für den Treppenmodus sowie Transport im öffentlichen Verkehr. Reifen-Druck Empfehlung angepasst. Kleinere Verbesserungen für Software Version 23.4.9.		
Revision 4	3 Oct 2023	Phyllis Hofmann
Anpassungen für Software Version 23.9.11 (IG-88): Joystick Einstellungen, Fehlermeldungen. Vorsichtshinweis für maximales Gewicht im Rucksack wurde hinzugefügt. Kleine Verbesserungen bei einigen Warnhinweisen. Vereinheitlichung einzelner Begriffe		

## WELCOME

Congratulations on your purchase of Scewo BRO, the world's coolest power wheelchair!

Like a good friend, it is intended to be a reliable companion in your day-to-day life and to provide you with a great deal of freedom and independence. We are already excited to hear about your adventures together.

Please read these operating instructions<sup>1</sup> carefully. They contain all the information that you need regarding the wheelchair's functions and how to use it. Please pay special attention to the safety instructions.

Finally, we hope you enjoy your journey!



---

<sup>1</sup>Subject to misprints, errors or product changes.



# 1. IMPORTANT INFORMATION

## 1.1. PRODUCT RELEASE

This product complies with the following standards:

- EN 12184:2014 (Wheelchair Class B)
- EN 1021-1
- ISO 7176-01
- ISO7176-02-2
- ISO 7176-03
- ISO 7176-08
- ISO 7176-14
- ISO 7176-16
- ISO 7176-28 (stair-climbing devices)
- IEC 61000-4-3
- IEC 61000-4-2
- IEC 61000-4-8
- CISPR 11, Emissions limits group 1, class A (identical to EN 55011)

The lithium-ion battery complies with the following standards:

- UN 38.3

## 1.2. INTENDED PURPOSE



### **Only use the product after training and having passed the exam**

Before using the wheelchair, a test drive and training (including an exam) by trained personnel must be carried out in order to rule out possible problems with the operation due to any limitations the user may have.



### **Stair-climbing device with increased risk compared to a conventional wheelchair**

Scewo BRO is a stair-climbing wheelchair. The stair-climbing function entails an inherently increased hazard and requires the user to possess a degree of supplementary knowledge and skills (see below). Please keep this in mind and only use the device if you meet all the requirements and agree with them.

The Scewo BRO wheelchair is designed for both indoor and outdoor use. It drives on two wheels in a self-balancing manner and can climb straight stairs. The tracks have been designed to climb stairs and are for use on solid ground only. Using the wheelchair in environments with loose objects (e.g. forest floor, gravel paths, sand) may cause additional wear and tear or cause the wheelchair to slip.

The wheelchair can be used by people both with and without physical disabilities. It may only transport one person (user/occupant). **Scewo BRO is exclusively approved for persons who have received and successfully completed training provided by Scewo or an official reseller. This means that if the owner changes, the training must be repeated by the new owner.** Steering is performed exclusively by the user using a joystick. The user must be cognitively and physically able to operate this power wheelchair including its control panel.

### 1.2.1. KEY SPECIFICATIONS

Mode	Max. speed	Max. load (user and luggage)	Max. incline
Drive mode	10 km/h <sup>a</sup>	120 kg	6° / 10.5 %
Stair mode	30 steps/minute	120 kg	36° / 72.6 %

<sup>a</sup>Country-specific variations possible

**Table 1. Summary of the main specifications for drive and stair mode**

### 1.2.2. INDICATIONS

The Scewo BRO wheelchair is designed specifically for people who can no longer walk and climb stairs or who suffer from a progressive medical condition and are able to get around independently in their day-to-day lives. The Scewo BRO wheelchair can be used with no functioning upper body muscles as long as the user can operate a conventional joystick. The following is a list of conditions for which the Scewo BRO can be an ideal solution:

- Tetraplegia or paraplegia
- Multiple sclerosis
- Cerebral palsy
- Muscular dystrophy
- General weakness in leg or respiratory muscles, e.g. as a result of ageing.
- The user must be able to look down the side of the wheelchair (at the level of the back support) to correctly activate the transition to the flat surface when they get to the top of the stairs.

### 1.2.3. CONTRAINDICATIONS

The most common contraindications to using a self-balancing and stair-climbing wheelchair are as follows:

- **A suitability test for Scewo BRO has not been completed:** Prior to use, it is essential that the user completes a training course and passes the suitability test in order to minimise the risks associated with using the wheelchair.
- **User's weight exceeds the specifications:** The user must not exceed or be under a certain maximum or minimum weight (see [Technical Specifications \[118\]](#)).
- **Impaired cognitive abilities (e.g. dementia):** It is very important that the user is aware of the additional dangers associated with going up and down stairs and that they never forget to switch to stair mode before climbing stairs. There is an increased risk of accidents in the case of impaired cognitive abilities.
- **Reduced bone density, brittle bones, etc.:** The wheelchair can trigger a relatively abrupt emergency brake in the event of an emergency. If bones are already quite weak, this could result in fractures/breaks. If this is the case, you should visit your doctor for a bone density measurement and consultation.

- **Severe limitation of movement or severe contractures:** If the user makes very strong and sudden movements while the device is in balancing mode, it may accelerate sharply or even tip over. It is essential to consult a trained specialist from an official Scewo reseller.
- **Inability to use a joystick:** At present, it is only possible to operate the wheelchair using a joystick. Special controls will follow in the future. Please contact us to discuss your requirements.

### 1.3. TECHNICAL SUPPORT

If you experience technical problems, please contact an official Scewo reseller or Scewo directly. You can find the official resellers' contact details on our website.

(Contact details can be affixed here).

### 1.4. WARRANTY CONDITIONS

The warranty conditions signed together with the purchase contract apply at all times.

The Scewo BRO power wheelchair is supplied with a product warranty. The batteries and charger supplied are also covered by a warranty. The warranty periods apply as of the date of delivery.

The warranty is only valid in the event of a defect in the material or workmanship of the wheelchair. The warranty does not apply if the wheelchair is used improperly or damaged in an accident or due to "force majeure", e.g. flood, hurricane, earthquake, fire, etc.

The warranty will be void if accessories other than those supplied with the product are used, if modifications are made to the product, or if routine maintenance is not carried out.

The warranty does not apply if the wheelchair is purchased from an unauthorised reseller or distributor. The warranty does not cover normal wear and tear. The tracks are intended for use on solid ground. Using them in environments containing loose elements (e.g. forest floor, gravel paths, sand) may result in additional wear and tear.

### 1.5. LIABILITY

Scewo accepts no liability for any material damage or personal injury resulting from failure to comply with the warnings and instructions provided in these operating instructions.

### 1.6. SYMBOLS

The following symbols are used in these operating instructions to indicate hazards and safety precautions, and to highlight important information. Failure to follow these instructions, especially the hazard warnings, may result in serious accidents or even death.

**Warning**

Hazard warnings which, if not heeded, may result in serious injury or death.

**Caution**

Reference to potential hazards that may arise from improper use.

**Note**

Useful information and tips on how to use the wheelchair.

## 1.7. OBLIGATION TO REPORT INCIDENTS THAT HAVE OCCURRED WITH THE DEVICE

Scewo BRO is a class I medical device. If you notice any faulty or even dangerous performance while using the device, you are obliged to report this to Scewo without delay. This enables us to alert other users and initiate any necessary measures and improvements.

## 1.8. BRO CERTIFICATE

When you collect your wheelchair purchased from Scewo or authorised reseller, you will need to complete a training and exam together with a specialist. This will ensure that you are fully acquainted with all of the wheelchair's functions and potential hazards. It is at the specialist's discretion whether this training session will be sufficient or if you need more practice before you can take the wheelchair with you. Adequate knowledge about the wheelchair and how to use it safely are prerequisites for every user.

**Never permit untrained users to operate the Scewo BRO**

Never entrust the wheelchair to a person who has not undergone a training and exam together with a specialist. Failure to inform the user of the potential dangers could result in serious accidents for which you may even be held liable.

## 2. PRODUCT DESCRIPTION

### 2.1. OVERVIEW



**Figure 1. Overview of components**

**The standard wheelchair model consists of the following components.<sup>2</sup> The integrated seat lift enables the seat to be lowered:**

1. Self-balancing wheels/undercarriage with pneumatic tyres
2. Seat system with folding back support (angle can be adjusted electrically)
3. Extendable tracks
4. Support system (rear support wheels)
5. Arm support (foldable)
6. Foot support (angle can be adjusted electrically)
7. Control panel
8. LED lighting
9. Valuables pouch incl. USB charging socket
10. Scewo backpack (non-detachable)

<sup>2</sup>Design may vary.

## 11. Anti-tip system (ATS)

Range of accessories also available. You will find an updated list of all accessories available on our [Website](#).

## 2.2. LABELS

The wheelchair is equipped with labels containing important information on its safe and proper use. These labels must not be removed and must remain visible at all times. If a label is damaged or illegible, you can order a new one from Scewo or your reseller.

### 2.2.1. NAME PLATE WITH SERIAL NUMBER



Figure 2. Name plate

### 2.2.2. USE ONLY AFTER TRAINING AND EXAMINATION

An introductory training session and exam must be provided by Scewo or an official reseller before the device, and in particular the stair mode, may be used. See also [BRO Certificate \[12\]](#)



Figure 3. Use only after successful completion of training and examination

### 2.2.3. MAIN SWITCH AND BRAKE RELEASE

The label indicates the position in which the switch must be in order to turn the main power supply on or off.

Moreover, the label indicates the button that releases the wheelchair's brakes in order to operate the wheelchair in manual push mode (see [Manual Emergency Operation \(Push Mode\) \[94\]](#)).

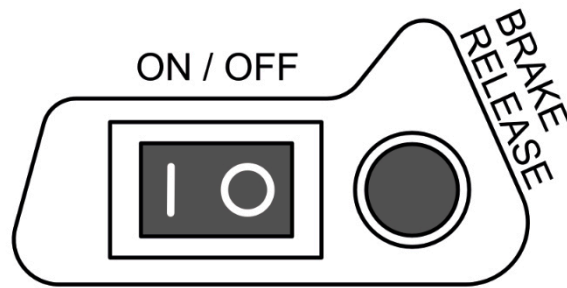

Figure 4. Labelling of main switch and brake release

**2.2.4. NOT PERMITTED FOR USE AS A SEAT IN A MOTORISED VEHICLE**

This label indicates, that the wheelchair is not permitted for use in motorised Vehicles. Further information can be found in section [Transporting the Wheelchair \[87\]](#)



Figure 5. Not permitted for use as a seat in a motorised vehicle

**2.2.5. CRUSHING HAZARD**

The wheelchair is heavy and comprises a large number of movable parts. In a worst-case scenario, a finger or other limb could get trapped. The label indicates a crushing hazard.



(a) Variant 1



(b) Variant 2

Figure 6. Crushing hazard

## 2.3. BRO-BACKPACK AND VALUABLES POUCH



### Do not transport fragile items in the backpack

Do not transport any items in the backpack that can break easily. Driving over bumpy terrain can cause product damage due to impact.



### Maximum weight in the BRO backpack

Make sure that the total weight in the backpack does not exceed 10 kg. If you use BRO as a [passenger \[86\]](#) while traveling in a vehicle, reduce the weight of the load in the backpack to 4 kg. The items in the backpack and your body weight combined must not exceed 120 kg. See the following [illustration \[16\]](#).

A valuables pouch is located under the seat. This means you can keep your valuables close at hand.

A backpack is attached to the back support. It contains enough space to hold your daily essentials.



Figure 7. Maximum weight in the backpack

## 2.4. LED LIGHTS

The wheelchair is equipped with LED lights at the back and on the sides, which light up in different colours depending on the situation. The lights are automatically activated when the wheelchair is switched on. You can dim the lights or switch them off completely using the app. The front lights are white. If you apply the brakes forcefully, the rear light lights up in bright red to alert oncoming road users (brake light).<sup>3</sup>

<sup>3</sup>The behavior of the LED lights may vary slightly depending on the country.



## 2.5. TURN INDICATOR

The side and rear LEDs can also be used as turn indicators. To activate the indicator, swipe the touchpad in the direction in which you would like to turn.<sup>4</sup>

## 2.6. LIFTING POINTS

Scewo does not advise lifting the device, but rather recommends using a ramp to lift it onto lifting platforms or other similar elevated obstacles.



### **Never lift while in drive mode**

Never lift the wheelchair while it is in drive mode! If the wheelchair tips only slightly in one direction, the motors may instantly accelerate to maximum speed and the wheelchair may start to move uncontrollably and may cause injury to you and bystanders.



### **Switch the device off before lifting it**

Before lifting the device, turn it off completely with the main switch.

If the wheelchair still needs to be lifted by a crane, for example, use the main wheels. For example, you can thread a rope through the spokes and attach this rope to the crane. Lift the wheelchair carefully and slowly and never stand under the suspended load.



### **Check the fit of the wheels before lifting**

Before lifting, check whether the wheel screws are well tightened.



### **Never lift from points other than main wheels**

Never lift the wheelchair with a crane or similar at points other than the main wheels! These points are not designed to withstand such loads and could break.



### **Guide the device while lifting it, prevent it from tipping**

If you lift the device using the two wheels, it can tip forward or backward. Guide the device with your free hand or attach a third point to a fixed connection on the wheelchair (e.g. the shaft under the front edge of the seat to which the footrest is attached).

<sup>4</sup>The behavior of the LED lights may vary slightly depending on the country.

### 3. ADAPTING THE WHEELCHAIR TO THE USER



**Calibrate the device before using it for the first time and when changing users**

Changes to the seat settings alter the center of gravity. The user’s weight including additional load may change when the user changes or as a result of external factors. Before using the wheelchair for the first time, it is essential to recalibrate the center of gravity (see Section [Calibrating the Center of Gravity \[40\]](#)). Failure to comply with this requirement may result in accidents caused by an increased braking distance or toppling over on stairs, and may even result in the death of the occupant.

A specialist must adjust the wheelchair for you before you use it for the first time. This is carried out either at the reseller where you purchased your wheelchair or at Scewo’s headquarters. This section contains further information on the various settings.

#### 3.1. JOYSTICK

The joystick can be adjusted to your needs using various settings. The goal is for the movement of the wheelchair to reflect the user's input into the device,.

The basic settings are made by Scewo or your Scewo reseller upon delivery.

<b>Adjustment of joystick for different needs<sup>a</sup>.</b>	
Tremor	The sensitivity of the joystick can be reduced so that small movements of the joystick do not affect the behavior of the wheelchair.
Muscle weakness	Changing the settings can, for example, reduce the effort required to move the joystick out of the neutral position.
Reduced and limited fine motor skills	If limited fine motor skills do not allow movement in one direction or only allow it to a limited extent, the required deflection of the joystick to move the wheelchair in this specific direction can be reduced.
Reduced range of motion	It is possible to define a smaller range of motion for the joystick to operate the wheelchair. This is applicable to specific directions, where the unaffected directions do not need to be changed.
Spasticity	With impaired range of motion and/or increased muscle tone, the strength of the deflection or the zone in which the joystick input results in movement of the wheelchair can be reduced or enlarged.

<sup>a</sup>Settings are adjusted by Scewo or reseller

**Table 2. Joystick settings**

<b>Adjustment of joystick by user</b>	
Turning speed	With this setting the speed of turning can be changed. When the slider is positioned all the way to the left, turning is reduced to minimum speed.

**Table 3. Joystick setting adjusted by the user**

## 3.2. BACK SUPPORT

### 3.2.1. ADJUSTING THE ANGLE OF THE BACK SUPPORT ELECTRICALLY

The angle of the back support can be adjusted electrically via the app or the control panel. You can find out how to do this in the app instructions and in the section on [Mechanical Adjustment of the Length of the Arm Support \(Control Panel Position\)](#) [22].



#### Automatic back support movements

The angle of the back support has a significant influence on the user's center of gravity. For this reason, the maximum adjustable angle may be reduced in certain operating modes (e.g. drive mode and stair mode). Before the wheelchair switches mode, the back support will automatically return to the permissible range.

### 3.2.2. FOLDING OF THE BACK SUPPORT

1. Remove the back cushion [Back Cushion \(Accessory\)](#) [26]
2. Release the locking mechanism (depending on the version installed):
  - a. Pull out the two lower locking bolts at the knob towards the center. The bolts lock into place when in this position. The two red buttons protrude.
  - b. Pull the strap midway between the two locking bolts. This releases the bolts (but they do not click into place).
3. Fold down the back support using a controlled movement.
4. To raise the back support up again, lift up the back support and press the two protruding red buttons one after the other. This will click the bolts back into place.
5. Check that the back support is securely locked in place by jiggling it.

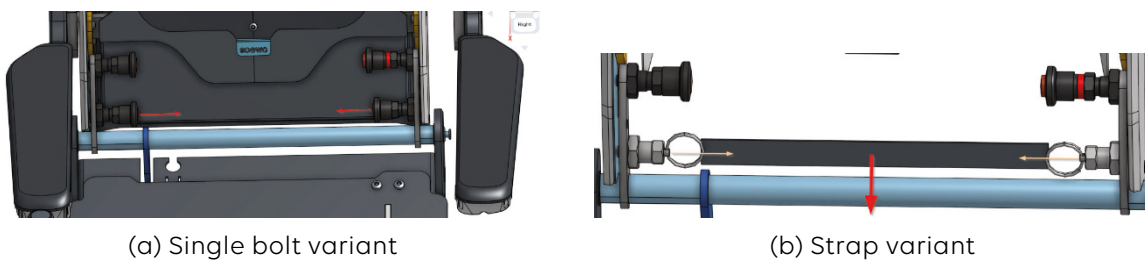
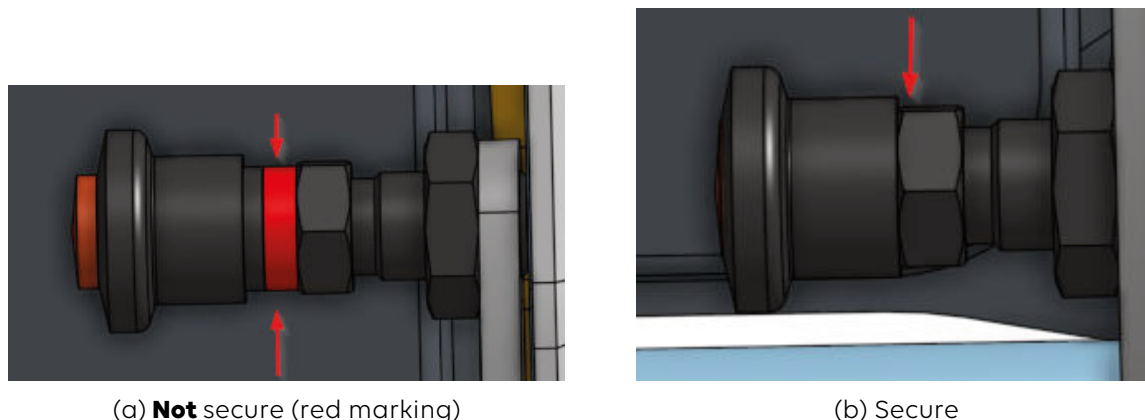

**Figure 8. Locking bolts to be unlocked in order to fold the back support**



#### Check that the back support is fixed into place

Make sure that both locking bolts have fully clicked back into place after folding up the back support. The red marking on the side should no longer be visible (see [Figure 8, "Locking bolts to be unlocked in order to fold the back support"](#) [19]) If the bolts are not fully clicked into place, the back support could fold down unintentionally, e.g. when leaning on the arm supports.



**Figure 9. Make sure that the back support locking mechanism is securely in place.**

### 3.2.3. REMOVING THE BACK SUPPORT

The back support can be detached completely from the wheelchair via a quick release system. This is useful, for example, when loading the wheelchair into a small car:

1. The cable leading up from the base must be unplugged in the back. To do so, unfasten the fabric cover at the Velcro strip on the base and fold it upwards so that the cable connection is visible.
2. Fold down the back support.
3. From behind, pull out the upper locking bolts at the knob towards the center.
4. The back support is now completely detached from the base and can be removed.

## 3.3. ARM SUPPORTS

### 3.3.1. DISMANTLING THE ARM SUPPORT

1. Remove the back cushion
2. If a cable is attached at the height adjustment: Unplug the cable from the box in the back support, remove the cable tie and guide the cable outwards.
3. Loosen the two height adjustment screws [Figure 10, "Removing the arm support" \[21\]](#). It may be a good idea to remove the plastic inlay to obtain easier access to the screws. To do so, remove the two inlay screws [Figure 10, "Removing the arm support" \[21\]](#)
4. The arm support can now be lifted outwards.



(a) Screws to be loosened in order to remove the arm support

(b) Screws to be loosened in order to remove the back support inlay

**Figure 10. Removing the arm support**

### 3.3.2. MECHANICAL ADJUSTMENT OF THE ARM SUPPORT HEIGHT

The height of the arm supports can be adjusted mechanically. The integrated scale will help you adjust both arm supports so that they are at the same height. The dimensions refer to the height of the arm support above the seat plate (with the arm support at a horizontal angle). Proceed as follows when you want to adjust the height:

1. Dismantle the arm support and pull it outwards (see [Figure 10, "Removing the arm support" \[21\]](#) . A toothed component will fall out, which is used to lock the height into position. See [Figure 11, "Toothed component used for height adjustment" \[21\]](#).
2. Reattach the arm support from the side at the required height (refer to the scale). Do not forget the toothed component.
3. Reassemble everything in reverse order. Remember the cable tie!

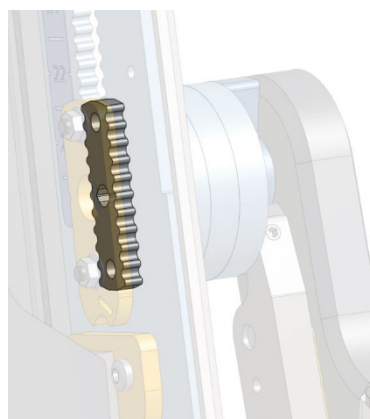

**Figure 11. Toothed component used for height adjustment**

### 3.3.3. MECHANICAL ADJUSTMENT OF ARM SUPPORT ANGLE

The angle of the arm supports can be adjusted mechanically. To do so, turn the set screw shown.

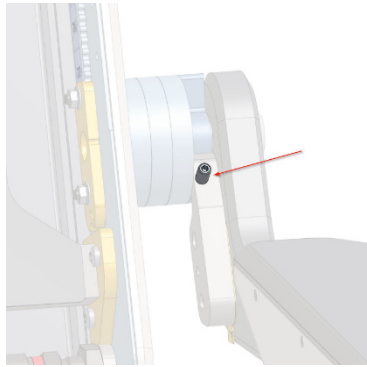

**Figure 12. Set screw for adjusting the arm support angle**

### 3.3.4. MECHANICAL ADJUSTMENT OF ARM SUPPORT WIDTH

The width of the space between the arm supports can be adjusted mechanically. This requires the use of compatible spacers and screws of a corresponding length, which are available from any Scewo reseller. To do so, proceed as follows:

1. Dismantle the arm support and pull it outwards (see [Dismantling the Arm Support \[20\]](#) )
2. Loosen the inner screw in the center (see [Dismantling the Arm Support \[20\]](#).)
3. You can now remove the spacers and the joint from the rest of the arm support.
4. Remove the shoulder screws already in place (see [Dismantling the Arm Support \[20\]](#)).
5. Insert the required number of spacers.
6. Insert two new shoulder screws that are the correct length.
7. Reassemble everything in reverse order. Remember the cable tie!

**Very narrow adjustment of the arm support width:** If the arm support width is still too big even if no spacers are used, the left and right arm supports can be swapped around. The shape of the padding makes it possible to adjust the width even more narrowly.

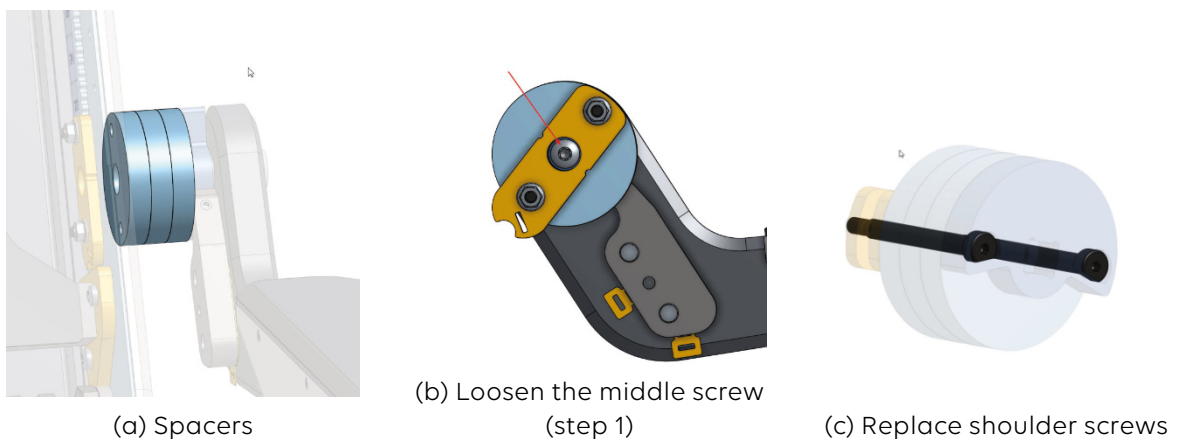
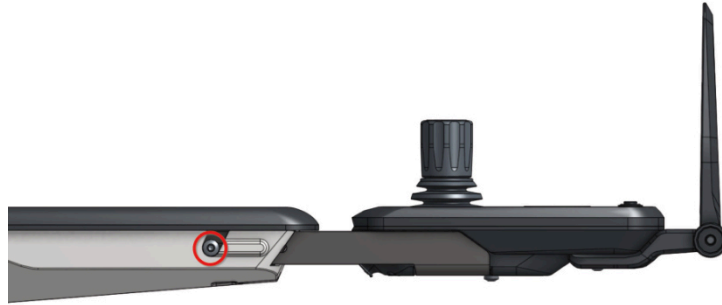

**Figure 13. Adjusting the width of the arm support**

### 3.3.5. MECHANICAL ADJUSTMENT OF THE LENGTH OF THE ARM SUPPORT (CONTROL PANEL POSITION)

The position of the joystick/control panel can be adjusted mechanically to accommodate the length of your forearm. To do so, proceed as follows:

1. Loosen the two screws (Figure 14, "Screws to be loosened to adjust the position of the control panel (loosen on both sides)" [23]).
2. Slide the control panel as far forward or back as desired.
3. Refasten the two screws until they are hand-tight.



**Figure 14. Screws to be loosened to adjust the position of the control panel (loosen on both sides)**

### 3.3.6. FOLDING THE ARM SUPPORTS UP AND DOWN

The arm supports can be folded up and back down. This makes it easier for you to transfer or sit closer to a table, for instance.



#### **Setting the amount of force required to fold the supports**

It is possible that the force required to fold the supports may decrease over time as the screws become looser. If you wish to adjust the force, tighten the shoulder screw as shown in [Mechanical Adjustment of Arm Support Width \[22\]](#).

## 3.4. LEG SUPPORT

### 3.4.1. MECHANICAL ADJUSTMENT OF THE LENGTH OF THE LEG SUPPORT

The leg support can be adjusted mechanically by loosening and retightening the screws indicated. The scale which can be seen on the inner side helps to adjust both sides of the foot support to the same length. The measurements refer to the distance between the seat plate and the foot support.

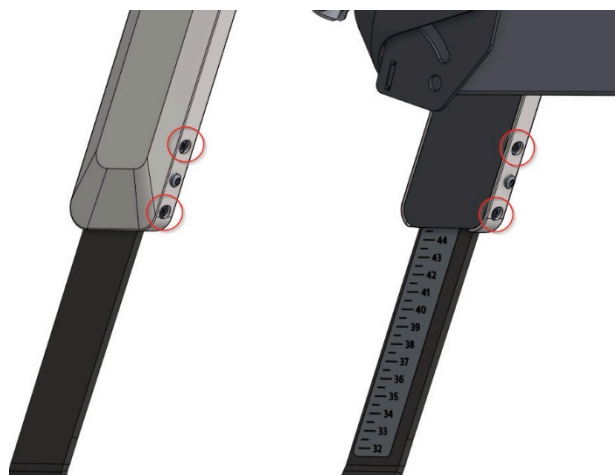

**Figure 15. Set screws to adjust the length of the leg supports**

### 3.4.2. ADJUSTING THE ANGLE OF THE LEG SUPPORT ELECTRICALLY

The angle of the leg support can be adjusted electrically. You can find out how to do this in the app instructions. It can also be set using the control panel. How this works is outlined in the section on [Adjusting the Seat Motors Via the Control Panel \[44\]](#).



#### **Automatic leg support movements**

The angle of the leg support has an effect on the ground clearance while in drive mode. For this reason, the maximum adjustable angle may be reduced in certain operating modes (e.g. drive mode). Before the wheelchair switches mode, the leg support will automatically return to the permissible range.

## 3.5. FOOT SUPPORTS

### 3.5.1. MECHANICAL ADJUSTMENT OF THE FOOT SUPPORT ANGLE

The mechanical adjustment of the angle of the foot supports can be done by manipulating the market screws.

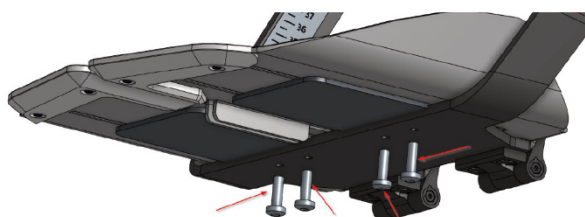

**Figure 16. Set screws for the foot supports angle adjustment**



### 3.5.2. FOLDING THE FOOT SUPPORTS UP AND DOWN

The foot supports can be folded up and lowered down individually and by hand. This is useful especially when getting in and out of the wheelchair.

## 3.6. SEAT

### 3.6.1. ADJUSTING THE POSITION OF THE SEAT LIFT



#### Increased braking distance when the seat lift is extended forward

If you move the seat lift forward, the center of gravity is shifted forward and the braking distance may increase significantly, especially on slopes. For this reason, always move the seat slider as back as far as possible before going down a slope.



#### Always recalibrate the center of gravity after adjusting the seat lift in drive mode

If the seat lift has been adjusted in drive mode, it is absolutely essential that the center of gravity is recalibrated (see [Calibrating the Center of Gravity \[40\]](#)). Otherwise, this could impair the wheelchair's driving performance.



#### Limited adjustment of the seat lift in some operating modes

Depending on the operating mode, you can only adjust the seat lift within a limited range or not at all.

The position of the seat lift can be adjusted forwards or backwards electrically to suit your desired seat height when the wheelchair is in park and drive mode. To do so, proceed as follows:

1. Connect to the app and adjust the position of the seat lift via the app (see app instructions).
2. If you have adjusted the seat lift in **drive mode**, **it is absolutely necessary to recalibrate the center of gravity!**
3. If you have recalibrated the center of gravity, your preferred seat lift position will also be saved in drive mode and restored to the same position automatically the next time you use it.

You can also adjust the position using the control panel. How this works is outlined in the corresponding section on [Adjusting the Seat Motors Via the Control Panel \[44\]](#).

### 3.6.2. MECHANICAL ADJUSTMENT OF THE SEAT DEPTH

The seat depth can be adjusted mechanically in several intervals by loosening the screws as shown in [Figure 17, "Loosen screws \(four screws, circles\) to adjust the seat depth" \[26\]](#).

1. Loosen the four screws that adjust the seat depth.
2. Move the seat platform forwards or backwards to suit your desired seat depth. A rule of thumb is that there should be a space equivalent to approximately three to four finger-widths between the front edge of the cushion and the back of your lower legs.
3. Firmly tighten the four screws again (recommended torque: 25 Nm).

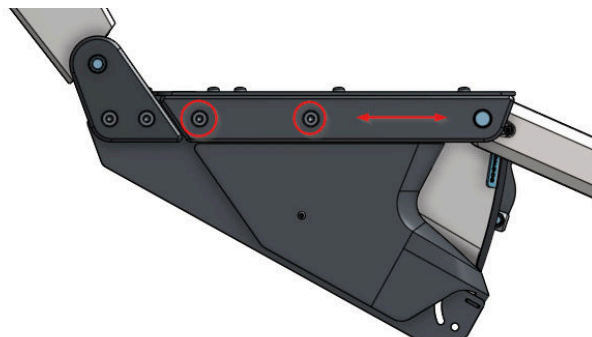

**Figure 17. Loosen screws (four screws, circles) to adjust the seat depth**

### **3.7. SEAT AND BACK CUSHIONS (ACCESSORY)**

The seat and back cushions are not included with the wheelchair. The suitable cushions for the wheelchair will be selected for you by a specialist.

#### **3.7.1. SEAT CUSHION (ACCESSORY)**

The seat cushion is very important to ensure that you are comfortable sitting in the wheelchair and to prevent pressure sores or other posture problems. Be sure to consult a specialist retailer before making a purchase and try out a variety of cushions. It is important that the seat cushion is firmly attached to the seat surface and not just laid on top of it (risk of slipping). Scewo recommends Velcro strips for this purpose:

1. Attach the supplied self-adhesive Velcro strips to the corresponding sections on your cushion. Remove the protective film.
2. Clean and remove any greasy spots from the seat surface (e.g. with denatured alcohol) to ensure the best possible adhesion of the glue.
3. Position the cushion on the seat in such a way that the Velcro strips adhere to the seat.
4. Remove the seat cushion and press the Velcro strips firmly into place.
5. The final position can now be adjusted easily thanks to the wide Velcro strips. Check that the cushion is correctly aligned (front and back as indicated on the sticker on the cushion).

#### **3.7.2. BACK CUSHION (ACCESSORY)**

The back cushion is very important to ensure that you are comfortable sitting in the wheelchair and to stabilise your upper body laterally. Consult a specialist retailer before making a purchase and try out a variety of cushions.

##### **Attaching and adjusting the height of the back cushion**



**Follow the instructions provided with your back cushion**

Special adapters and holders are included with most back cushions. Some also have quick-release systems, e.g. to remove the cushion from the back support quickly. Refer to the separate instruction manual for your back cushion for more details.

On the Scewo BRO, back cushions can be mounted at two different initial heights. There are two mounting holes, **each fitted with an M5 thread spaced 25 mm apart**. The height can then be adjusted precisely using the cushion adapters. The Scewo BRO fastening is compatible with the following back cushion systems:

- “Jay” model series by the manufacturer Sunrise Medical (adapters with a quick-release system can be screwed on directly).
- Back cushions produced by Scewo, which have been designed specifically for the BRO. More information is available on our website.

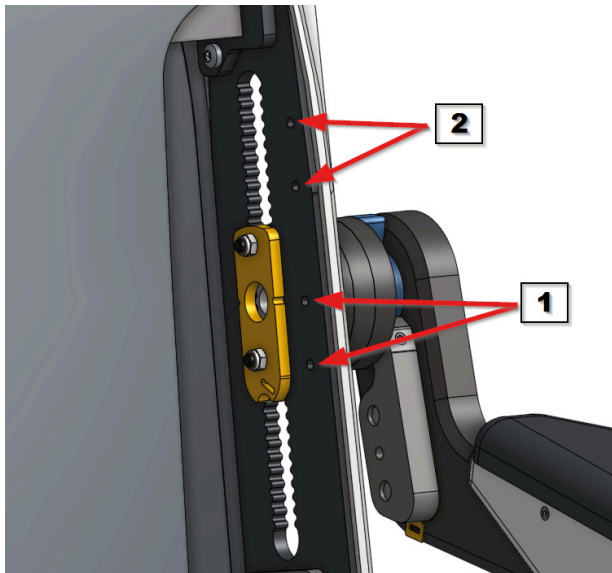

1. Lower fastening option
2. Upper fastening option

**Figure 18. Mounting holes for back cushion holders (two initial heights)**

**Adjusting the depth/angle of the back cushion**

The angle and depth of many back cushions can be adjusted. A range of different adapters or holders are also often available. Please refer to the separate instructions for your back cushion and consult a specialist reseller.

**3.8. HEAD SUPPORT (ACCESSORY)**

A head support can be attached additionally.

### 3.8.1. ATTACH/REMOVE THE HEAD SUPPORT

Proceed as follows when attaching a head support:

1. Remove the back cushion.
2. (Figure 19, "Attach/remove the head support" [28])
3. Insert the head support into the slot provided and secure the two supplied screws from below (recommended torque: 6Nm) (Figure 19, "Attach/remove the head support" [28])
4. Remount the textile cover.

To remove the head support, proceed in reverse order:

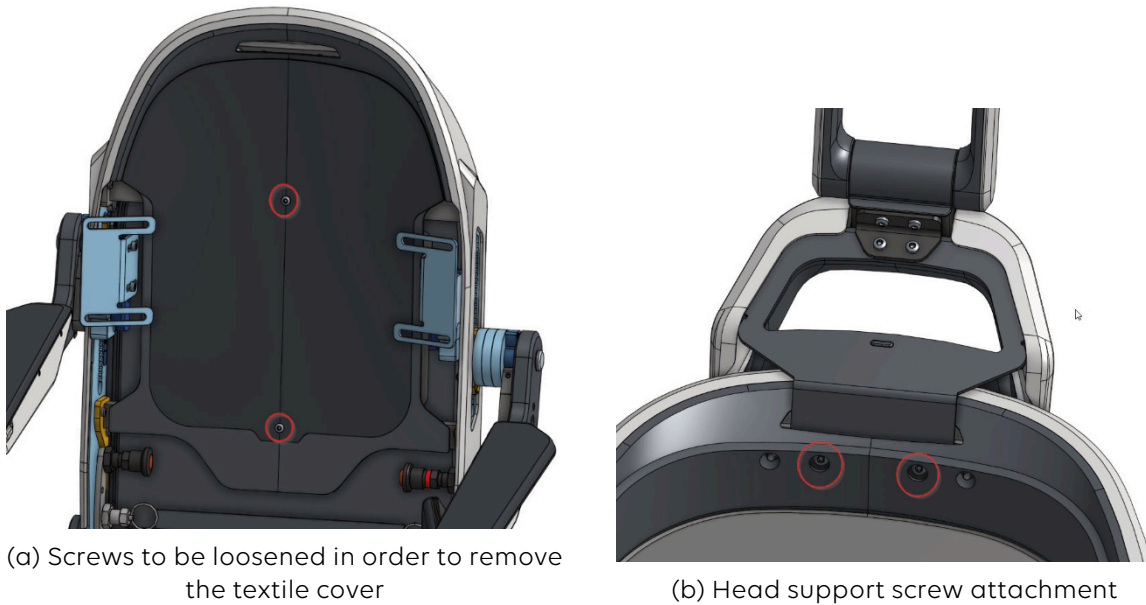

**Figure 19. Attach/remove the head support**

### 3.8.2. ADJUSTING THE HEAD SUPPORT

Proceed as follows to adjust the head support to meet your requirements:

#### Adjusting the angle

1. Remove the two coloured coverings on each side. To do so, remove the screw located in the center of the covering and pull carefully on the covering.
2. Loosen all four screws on the locking discs (larger screw in the center) (on each side). (Figure 20, "Head support adjustment" [29]). Do not remove the screws completely.
3. Adjust the angle to suit your preference .
4. Tighten the four screws again (recommended torque: 6Nm)
5. You may now need to adjust the height of the head support.
6. If you are satisfied, put the side coverings back on and lightly tighten the middle screw.

#### Adjusting the height

1. Remove the rear, upper cover (in gray). To do this, insert a thin object at the top and push the cover backwards/downwards. The cover is only clamped and will come off with sufficient force.
2. Loosen all four screws (Figure 20, "Head support adjustment" [29]). Do not remove the screws completely.
3. Adjust the height to suit your preference .
4. Tighten the four screws again (recommended torque: 3Nm).
5. If you are satisfied with the height, replace the rear upper covering.

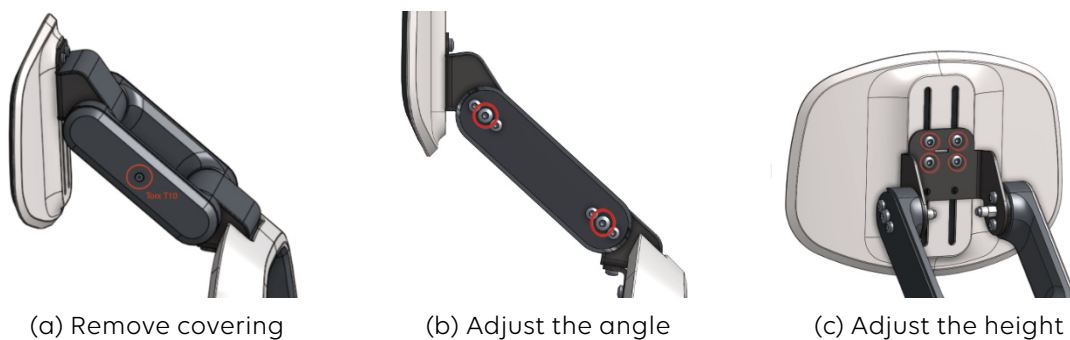

Figure 20. Head support adjustment

### 3.9. LATERAL THIGH SUPPORTS (ACCESSORY)

The lateral thigh supports can be mounted optionally. These supports are installed by an official reseller or directly by Scewo.

The thigh supports can be pulled up and away for an easier transfer. The pulled-out support can be attached to the second, remaining support using a magnet (so that it remains easily accessible).



**Figure 21. Optionally available lateral thigh supports**



**Warning for people with a pacemaker**

Magnets can affect the function of pacemakers and implanted defibrillators. As a wearer of such devices, keep the distance recommended by the manufacturer to the magnets on the parts marked with this sticker.



**Figure 22. Warning sticker "Caution Magnets"**

**3.10. MAGNETIC SMARTPHONE HOLDER "MAGIC MOUNT" (ACCESSORY)**

To make attaching and removing the smartphone as easy as possible, an optional magnetic smartphone holder can be purchased. It replaces the standard holder which uses a mechanical lock and is mounted directly on the control panel.

Please note that you need a corresponding magnetic case/adaptor for your smartphone in order to use this holder. You can find such cases in smartphone accessory stores.

Note: In the event of strong impacts, the magnetic forces may be too small and your smartphone may fall off the holder. We therefore recommend using a sturdy case and removing the smartphone or using the standard holder with mechanical locking when driving on terrain where strong impacts are expected. Scewo assumes no liability for damage to the smartphone!



**Figure 23. Magnetic smartphone holder**



**Warning for people with a pacemaker**

Magnets can affect the function of pacemakers and implanted defibrillators. As a wearer of such devices, keep the distance recommended by the manufacturer to the magnets on the parts marked with this sticker.



**Figure 24. Warning sticker "Caution Magnets"**

**3.11. CUP HOLDER "DRINK DOCK" (ACCESSORY)**

A drink holder can also be attached. Mounting the drink dock is possible on the left or right side.



Figure 25. Cup holder "Drink Dock"



**Careful with hot liquids!**

Very hot liquids (e.g. boiling water, hot tea, etc.) can deform the material or cause burns if they spill over.



**Do not lean on cup holder!**

Do not lean on the cup holder as it could break due to the high forces.



**Avoid spilling**

In stair mode or on uneven terrain, there is a risk of the drink spilling over the edge. Make sure the container is covered with a lid or that there is enough clearance at the top.

### 3.11.1. PLACING DRINKS IN THE DRINK DOCK

There are two clamps in the "Drink Dock" that serve to stabilize the drink. The drink is clamped between these clamps. When inserted from above, the shape of the clamps automatically adapts to the drink.

It is also possible to keep a wine glass in the drink dock. To do this, the stem of the wine glass must be passed through the slot in the bottom of the drink dock and the upper part of the glass must be placed on top of the clamps.

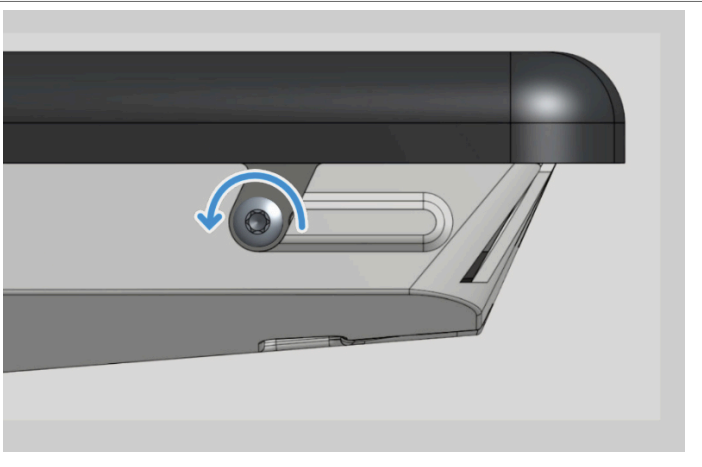
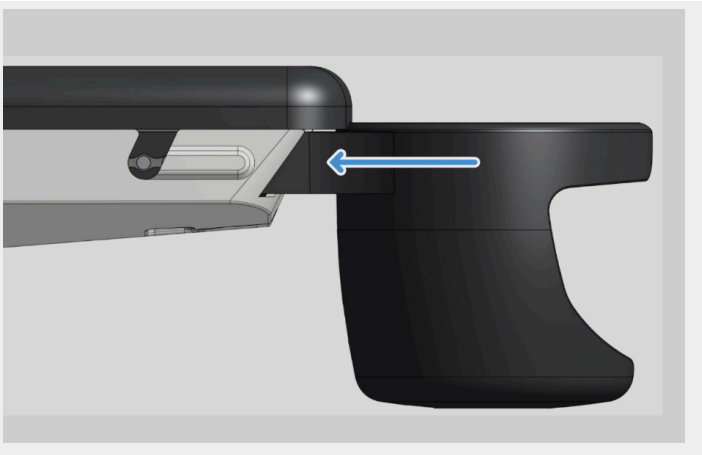
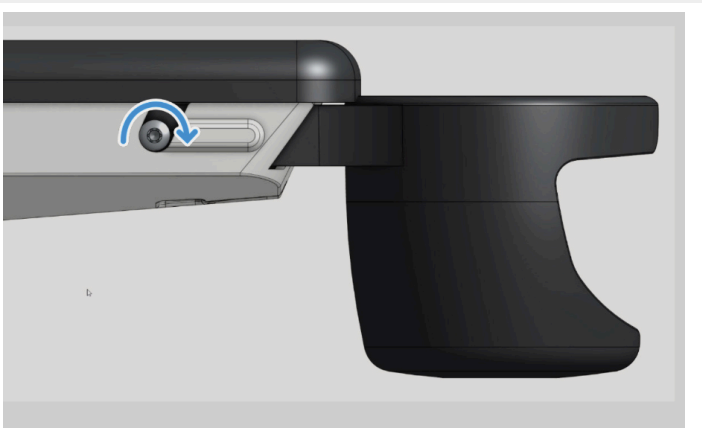

**3.11.2. ATTACH/REMOVE THE DRINK DOCK**

<p>1 Loosen the two screws on the desired arm support.</p>	 <p>A side-view technical drawing of the machine's arm support. A blue curved arrow indicates the counter-clockwise rotation of a screw being loosened from the support structure.</p>
<p>2 Slide the cup holder backwards into the existing slots until it is completely locked into place. The hole for the screws must be completely enclosed by the "Drink Dock" attachment.</p>	 <p>A side-view technical drawing showing the cup holder being moved into position. A blue arrow points from the right towards the cup holder, indicating the direction of movement into the slots.</p>
<p>3 Reinsert the screws and tighten them by hand.</p>	 <p>A side-view technical drawing showing the cup holder fully attached. A blue curved arrow indicates the clockwise rotation of a screw being tightened to secure the assembly.</p>

**Table 4. Attach/remove the Drink Dock**

**3.11.3. REPAIRING DEFORMATION OF CLAMPS**

In order to bring deformed clamps in the Drink Dock back into shape (e.g. due to drinks that are too hot), you can fix them in the desired position (for example by clamping an object between the clamps and the inner wall of the Drink Dock) and then place it in a hot water bath for 5-10 minutes.

## 4. CONTROL PANEL

With the control panel, the wheelchair can be turned on and off, and various modes and functions can be selected. The following sections will explain how you can switch between different driving modes and settings, as well as some prompts for when you need to do something with the joystick.

The control panel can also display a variety of errors and warnings. These are described in the relevant sections. See also [Error Messages \[108\]](#).



### **Do not lean on the control panels**

Never lean on the control panel. It could break off and you could injure yourself.

The following principles were adhered to in the design of the control panel:

- The LED ring always lights up in a specific colour for each mode. See [Overview of Operating Modes \[48\]](#).
- Only those modes that are currently available are displayed as an icon.
- Red icon: Error or urgent warning
- Orange icon: Warning or action by the user required
- Actuators (e.g. seat lift) move over longer distances only as long as the user has deflected the joystick. This way, the user can stop the movement at any time in case of a jammed component or body part.
- The standby button stops the movement of any motor at any time and can also be used as an emergency stop in drive mode.

### 4.1. OVERVIEW

The control panel consists of the joystick, the touchpad, an LED ring, and multiple buttons and status indicators. A smartphone holder is also available, which ensures that the installed apps are displayed clearly. [Figure 26, "Control panel" \[35\]](#) displays the control panel components:

1. Joystick
2. Standby button (standby/reset/emergency stop)
3. Menu button
4. Touchpad
5. Battery level indicator
6. LED ring
7. Smartphone holder
8. USB-C charging socket
9. Standby jack connector (for buddy buttons)
10. Menu jack connector (for buddy buttons)

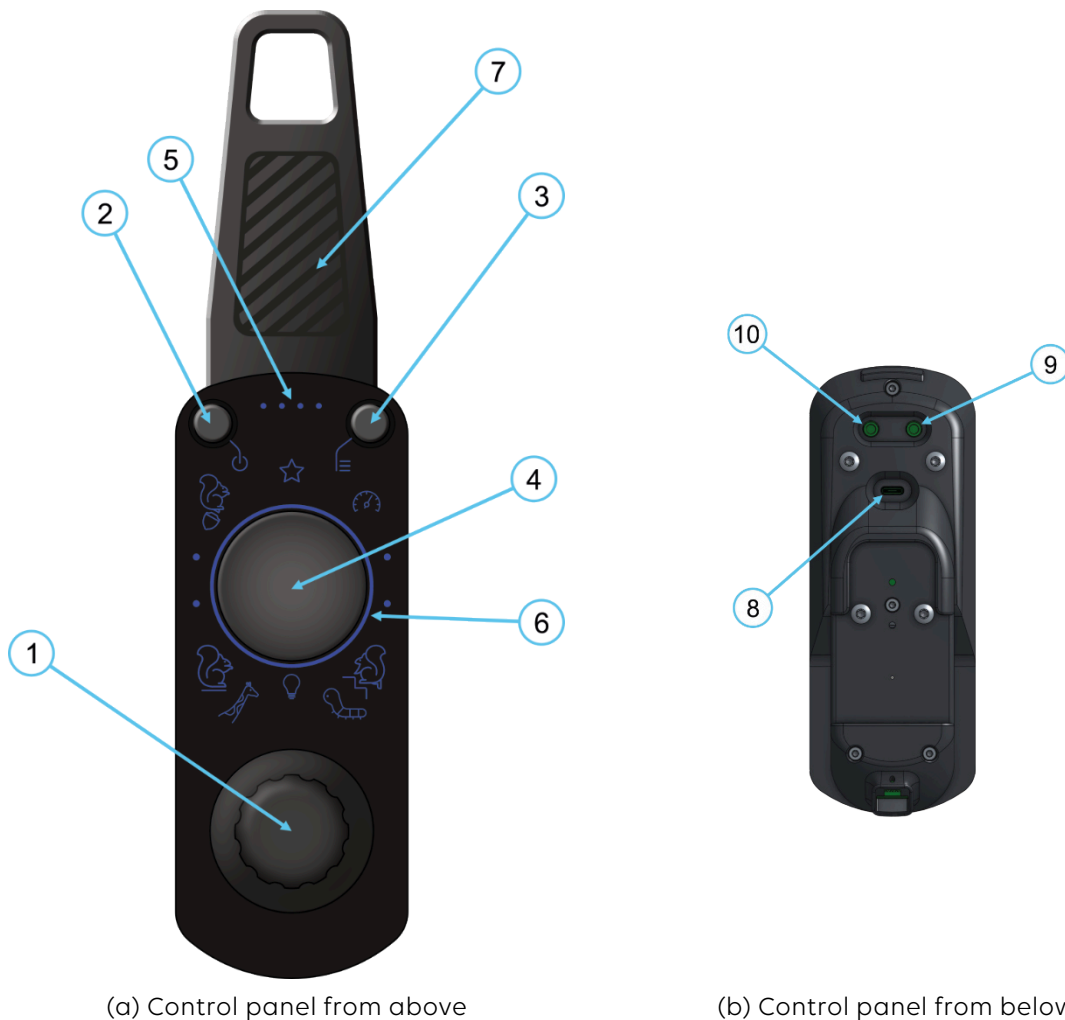

**Figure 26. Control panel**

A number of different icons may light up on the control panel. [Figure 27, "All available icons and indicators"](#) [36] displays all of the icons:

1. Drive mode icon
2. Speed level icon
3. Error indicator 1
4. Error indicator 2
5. (This has no function for now)
6. Error indicator 3
7. Stair mode icon
8. Track mode icon
9. (This has no function for now)
10. Elevate mode icon
11. Park mode icon
12. Warning/information indicator
13. Standby button/icon

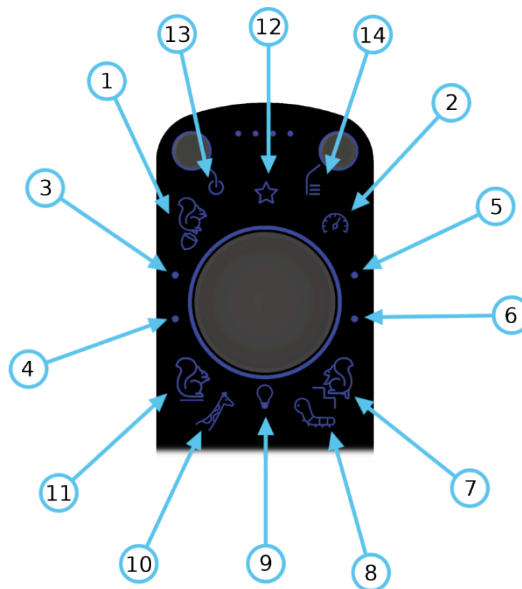

**Figure 27. All available icons and indicators**

#### 4.1.1. BATTERY LEVEL

Dots	Battery Level
4	80-100%
3	60-80%
2	40-60%
1	18-40%
1 (flashing red)	0-18%

## 4.2. OPEN MENU

You need to call up the menu first in order to switch between the different operating modes. Proceed as follows:

- Using the **menu button**: Press the button once briefly. The menu now appears.
- Using the **touchpad (tap)**: Double tap in the center of the touchpad. The menu will now also appear.
- Using the **touchpad (hold)**: Keep your finger on the center of the touchpad for at least two seconds. The menu now appears.

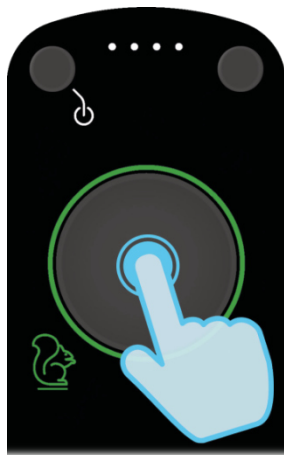

(a) Open the menu by double-tapping

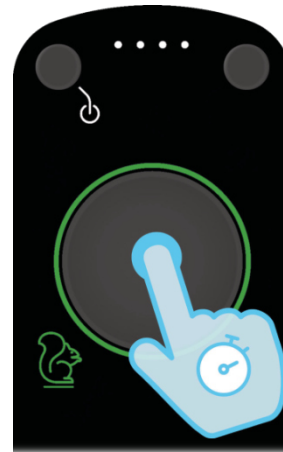

(b) Open the menu by placing your finger on the touchpad

**Figure 28. Ways to open the menu using the touchpad**

After the menu has been opened, the joystick is deactivated for steering the wheelchair and can be used to select the menu item.

## 4.3. SELECT MENU OPTION

After the menu has been opened, all available options are displayed with coloured icons. The available options may depend on the mode that is active and therefore vary depending on the situation. Proceed as follows to select an option:

- Using the **Joystick**:
  1. Move the joystick in any direction. A small cursor appears on the LED ring showing you the current direction of the joystick.
  2. Move the joystick until the cursor points to your desired new option.
  3. As soon as you have selected an available option, the LED ring will start to “fill up” in the colour of the option selected. Keep the joystick pointed at the option until the LED ring is fully filled with the new colour.
  4. Release the joystick once the ring is completely full.
  5. Your chosen option is now active.
- Using the **touchpad (tap)**: Tap your finger on the touchpad near the desired option and hold it there for a short moment until the LED ring has finished filling up with the new colour.

- Using the **touchpad (slide)**: Slide your finger from the center towards your desired option. Hold your finger at the edge of the touchpad for a few seconds until the LED ring is filled with the new colour.

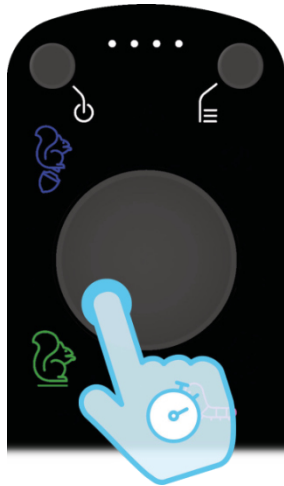

(a) Select option by tapping

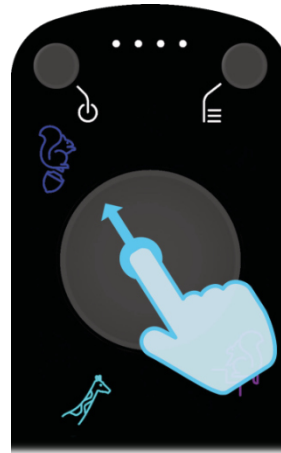

(b) Select option by sliding

**Figure 29. Ways to select a menu option using the touchpad. The option selected must be held until the LED ring is completely filled with the colour corresponding to the new mode selected (in this case, blue).**

#### 4.4. USER INTERACTION PROMPTS

In specific situations, the control panel will prompt you to move the joystick in a certain direction or to release it. Move the joystick in the direction indicated to complete an operation .

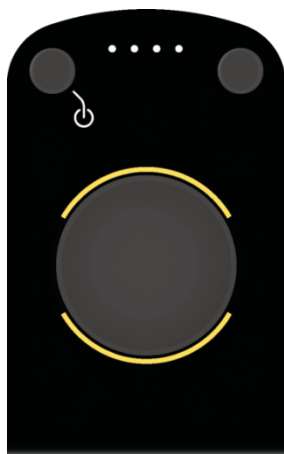

(a) Move joystick forward or back

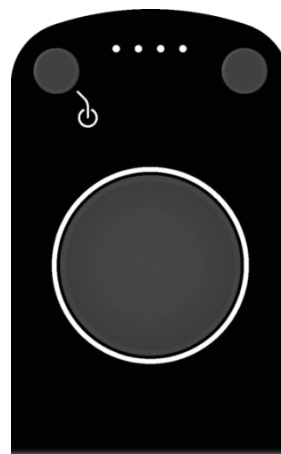

(b) Release joystick

**Figure 30. Prompt to move joystick accordingly**

## 4.5. WARNING INDICATOR

A warning is indicated by an orange circle. The control panel may also vibrate. Pay attention to your driving style!

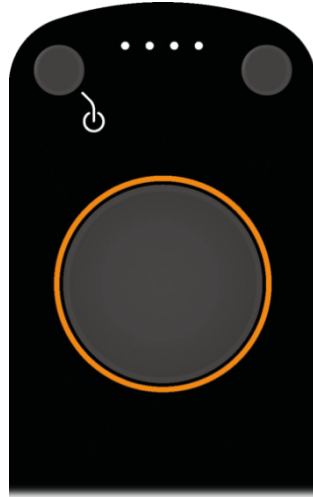

**Figure 31. Warning of dangerous situations - Pay attention to the warnings for your current driving situation!**

## 4.6. ERROR INDICATION

An error is indicated by a red circle .

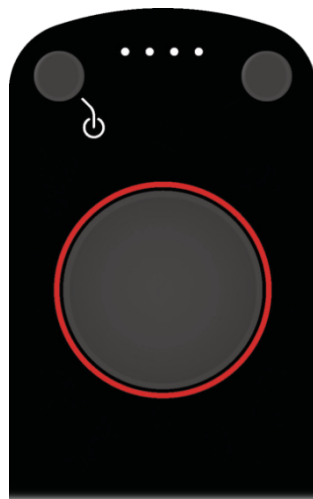

**Figure 32. An error has occurred. Refer to [Error Messages \[108\]](#) to find out what you need to do.**

## 4.7. DEACTIVATE/ACTIVATE TOUCHPAD

In some situations, it may be useful to deactivate the touchpad. For example, if it is defective, there is a lot of water on it, or you inadvertently touch it too many times because of impaired finger

dexterity. You can still use the joystick to access all key functions. Proceed as follows to deactivate the touchpad:

1. Pull over somewhere safe.
2. Press the menu button five times in quick succession.
3. The menu icon will light up in the following colours depending on the touchpad status:
  - White: Touchpad is activated
  - Yellow: Touchpad is deactivated
  - Red: Defect detected in touchpad or joystick

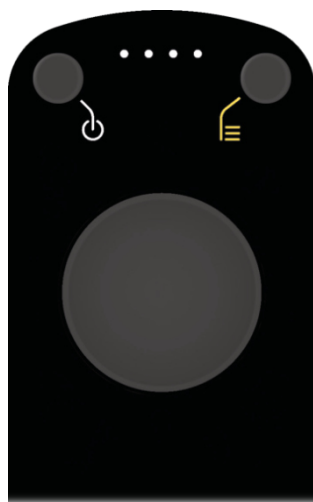

**Figure 33. The menu icon lights up in yellow when the touchpad is deactivated.**

The touchpad can also be deactivated permanently in the app.

## 4.8. DRIVE MODE SETTINGS

### 4.8.1. CALIBRATING THE CENTER OF GRAVITY

The occupant's center of gravity while seated is a very important parameter for the drive mode and needs to be calibrated in the software.



#### **Seat settings are saved simultaneously**

The electrical seat settings (e.g. angle of the back support) are relevant for the center of gravity. That is why these settings are saved along with the center of gravity and are automatically reset to the most recently saved parameters when drive mode is activated.



#### **Initial calibration of the center of gravity with the help of an assistant**

The wheelchair can jolt strongly during the initial (first) calibration. Therefore, during the initial calibration you should ask someone to help you and to stabilise it if necessary.



Proceed as follows:

1. Ensure that you are positioned on level ground. The center of gravity cannot be calibrated on a slope.
2. Make sure the ground is firm (no gravel, grass or similar).
3. Switch to drive mode. If this cannot be done because of a significant change in the center of gravity, ask someone to hold and stabilise the wheelchair firmly using the back support. Once drive mode has started properly, they can carefully let go of the back support so that the chair can find its balance (wheelchair moves slightly forwards or backwards before coming to a stop).
4. Keep the joystick in the center the entire time and remain seated in the wheelchair in the same relaxed way as you would normally. Be sure to lean against the back support.
5. Once the wheelchair has found its balance, press the **menu button three times in quick succession**. The wheelchair will respond as follows:
  - a. **LED ring lights up briefly in green:** Centre of gravity has been calibrated successfully
  - b. **LED ring lights up briefly in red:** Centre of gravity could not be calibrated. Please try again. The app will provide a more detailed error message.
6. **Check that the LED ring has lit up briefly in green.** The center of gravity has now been calibrated successfully.



**Possible causes of an error during calibration**

1. Center of gravity is much too far to the front/back (the wheelchair has to tilt forward or back significantly in order to come to a standstill): Adjust the center of gravity, e.g. by adjusting the angle of the back support, removing heavy items from the backpack, adjusting the seat depth.
2. Wheelchair is not standing still
3. Uneven ground: the calibration can only be carried out on a level surface.
4. System error

**4.8.2. BRAKING BEHAVIOR SETTING**

The braking behavior depends on your chosen "Fast Brake" setting, which can be changed in the app. "Fast Brake" is activated by default. "Fast Brake" can be deactivated for smoother braking. Scewo recommends deactivating "Fast Brake" for people who are not at increased risk of the joystick slipping out of their hands while driving.

- Left/Right: Direction control
- Push the joystick forward: drive forward
- Release:
  - **Fast Brake on (standard):** Initiate emergency brake, see [Emergency Brake \[62\]](#)
  - **Fast-Brake off:** Wheelchair rolls out and to a stop (normal braking)
- Pulling the joystick backwards
  - **Fast Brake on (standard):** Trigger emergency brake
  - **Fast-Brake off:** Trigger emergency brake

### 4.8.3. MAXIMUM SPEED IN DRIVE MODE



**Country-specific maximum speed**

The maximum permissible speed is programmed prior to delivery to 6 km/h or 10 km/h depending on the country. The maximum permissible speed is 6 km/h in most EU countries. Be sure to comply with your local rules and regulations.

The user can reduce the wheelchair’s maximum speed (to below the legal speed limit). This is particularly helpful for new users to become familiar with the wheelchair or in confined spaces, i.e. indoor areas.

Two predefined levels are available to switch quickly:

- Fast (speed icon lights up orange)
- Slow (speed icon lights up green)

**Changing the speed using the joystick:**

1. Make sure you are in drive mode.
2. Open the menu.
3. Select the speed icon using the joystick.
4. The maximum speed alternates between fast (orange) and slow (green).

**Changing the speed using the touchpad:**

1. Make sure you are in drive mode.
2. Open the menu.
3. Swipe your finger on the center of the touchpad upwards from the bottom (increase speed) or downwards from the top (decrease speed). The current level is shown in a segment at the top right of the LED ring: green means slow, yellow means fast.

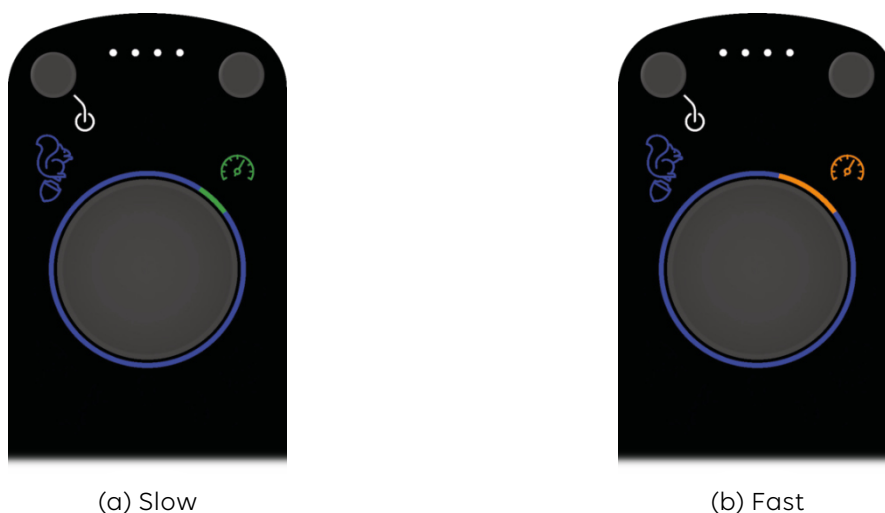

**Figure 34. Drive mode speed settings**

**'PRIVATE GROUND' FUNCTION (COUNTRY-SPECIFIC)**

The "Private Ground" function can be activated in the app. This temporarily increases the maximum possible speed to 10 km/h to get around faster on larger private properties. **Activating this function is your own responsibility. By activating the function, you automatically confirm that you are on private property where travelling at 10 km/h is permitted.**

The "Private Ground" setting is automatically deactivated again once the wheelchair is restarted.



**The "Private Ground" function is not permitted in public areas.**

Always comply with country-specific road traffic laws when increasing the speed from 6 km/h to 10 km/h via the "Private Ground" function. In many countries, the "Private Ground" function may not be activated on public roads, within the area of the German Road Traffic Licensing Regulations (StVZO) or similar properties. No liability is accepted for using this function on public property.

## 4.9. ADJUSTING THE SEAT MOTORS VIA THE CONTROL PANEL



### Be aware of crushing hazard

When adjusting the seat, be careful not to get yourself jammed in anywhere. Particular care should be taken under tables and benches.

Depending on the mode, you can adjust the various seat motors using the control panel. In addition to the normal menu where you can switch between the wheelchair's different operating modes, there is a secondary seat menu for changing the seat motors. The LED ring displays a white segment indicating each of the accessible motors. The currently selected motor is displayed as a green segment, see [???](#). A motor is shown as an orange segment if it cannot be adjusted in the current mode. This can be seen in [???](#). Proceed as follows to adjust a seat motor:

1. Press the menu button for approx. two seconds → Seat menu appears
2. Push the joystick to the left or right to select the desired seat motor:
  - Back support: Left segment
  - Seat lift: Middle segment
  - Foot support: Right segment
3. Push the joystick forward or backward to adjust the desired seat motor .
4. To exit the menu, press the menu button again.

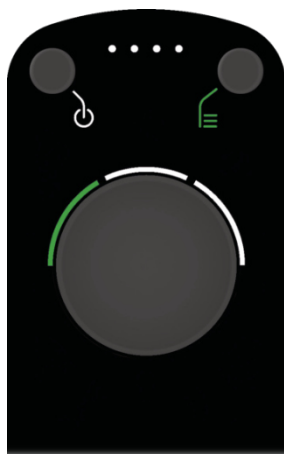

(a) Seat menu in which the motor for adjusting the back support can be selected.

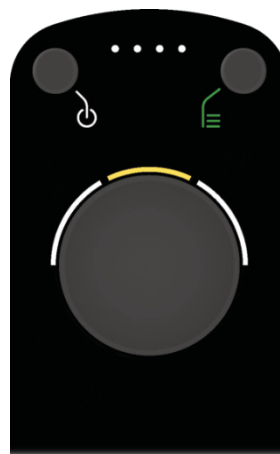

(b) The seat lift motor cannot be adjusted in stair mode.

**Figure 35. Seat menu in different operating modes**

## 5. OPERATING THE WHEELCHAIR

The following chapters explain how you should use the wheelchair in everyday life and in special situations. Before you use it for the first time, it is essential that you complete the steps outlined in the [Adapting the Wheelchair to the User \[18\]](#) section so that the wheelchair is optimally adjusted for you.

We recommend repeated test drives in familiar environments to familiarize yourself with how the wheelchair and accessories behave in different situations. You can then safely drive on public roads and areas.

The following sections will only explain how to operate the wheelchair using the control panel. To operate the wheelchair using the app, refer to the separate instructions for the app.

### 5.1. POWERING THE WHEELCHAIR ON AND OFF

#### 5.1.1. POWERING ON

1. Make sure the main switch at the back is set to the "on" position.
2. Press the standby button on the control panel. The wheelchair starts up (LED ring rotates).
3. Once the wheelchair is ready for use, the LED ring will light up in green. You are now in park mode. For more information, see [Park Mode \[49\]](#).



#### **Wheelchair will not power on**

If the wheelchair cannot be switched on using the standby button after a long period of standstill, the battery is probably in "deep sleep" mode. Turn off the main switch for at least 20 seconds and try again.



#### **Check power-on sound**

The wheelchair emits a chime when it is powered on. If this does not happen, the loudspeaker may be damaged. Take the Scewo BRO to maintenance so that the loudspeaker can be checked. The loudspeaker is important in order to warn you acoustically of any hazards.

### 5.1.2. POWERING OFF (STANDBY)

**If not used for more than 24 hours, turn off the main switch.**

To avoid problems with the battery when switching on, we recommend always switching off the wheelchair using the main switch if it is likely not used for more than 24 hours. After 24 hours, the battery automatically switches to "deep sleep" and can no longer be switched on using the standby button. See also section [Error Messages \[108\]](#).

1. Make sure you are in park mode
2. Press the standby button on the control panel. The wheelchair switches to an energy-saving standby mode (all LEDs switch off). From this mode it can be switched on again quickly by pressing the standby button .

**Using the standby button as an emergency stop**

You can return to park mode by pressing the standby button at all times. However, this is a fast shut-down, so the transition can be quite jerky. For this reason, you should only use this method in an emergency (see [Emergency Shutdown \[62\]](#))

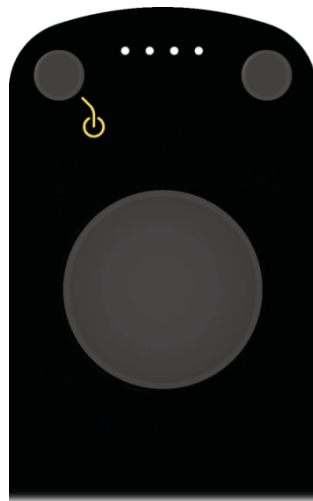

Figure 36. Standby mode display

### 5.1.3. POWERING OFF (STORAGE AND TRANSPORT)

The wheelchair should be powered off completely if you do not expect to use it for a longer period of time (more than 24 hours) or if it is to be transported. This procedure can also be used to disconnect the battery from the system in the event of an electrical fault or smoke being emitted by the wheelchair.

1. Make sure you are in park mode
2. Ideally, the battery charge level is around 60-70%.
3. Press the standby button on the control panel. The wheelchair switches off (all LEDs switch off).
4. Turn the main switch at the back to the "off" position. This separates the battery from the rest of the system and minimises power consumption. Nevertheless, you should recharge the battery every three months to prevent excessive discharge (battery self-consumption).

**Residual voltage**

There may be residual voltage left in some of the wheelchair's components for several minutes after it has been powered off. For this reason, it is normal for some LEDs to continue to emit a small amount of light.

**5.1.4. RESET**

If the wheelchair is in an undefined state due to an error, you can reset it and force a complete restart as follows:

**Never reset in drive mode**

Never perform a reset while the wheelchair is moving or on the stairs, instead only do so in a sheltered place and in park mode. The reset overwrites all safety functions and the wheelchair will reboot. If this is done in drive mode, the wheelchair could tip over due to stopping abruptly.

1. Make sure you are in park mode and in a safe place. The reset will take several minutes.
2. Keep the standby button pressed for at least 30 seconds.
3. A long, high-pitched beep is emitted as a warning that the reset is about to take place. Continue to keep the button pressed for a few seconds before releasing it.
4. The beeping will stop and the wheelchair will reboot.

**Reset during transition at the top of a stair**

If you have to perform the reset during the transition at the top of a stair (only in exceptional cases), you should note the following:

- End of stairs may have to be triggered manually
- Extreme caution is advised regarding the direction in which you want to go:
  - If the wheelchair is on the step edge, it should be moved backwards/upwards whenever possible.
  - If the support system is extended too early (support system not on the upper level → driving backwards is not possible), then you can go forward. However, the support system could drop a few cm to the next step below – (severe jerk and damage to the motor may occur).
  - If you are unsure, get help!

## 5.2. OVERVIEW OF OPERATING MODES

The wheelchair can cope with many different obstacles and challenges in day-to-day life. To do so, it must be switched to the correct operating mode. The wheelchair is moved and steered using the joystick on the control panel. The various modes, for example stair or drive mode, can also be selected via the app.

The following modes are available. Each mode is explained in detail in the relevant section:

Mode	Function	Colour	Section
Park mode	Getting in/out	green	<a href="#">Park Mode [49]</a>
Elevate mode	Seat height adjustment	turquoise	<a href="#">Elevate Mode (Seat Position) [51]</a>
Drive mode (balancing)	Travelling longer distances on normal terrain	blue	<a href="#">Drive Mode (Balancing) [53]</a>
Stair mode	Going up and down stairs and individual steps	purple	<a href="#">Stair Mode [63]</a>
Track mode	Going up and down steep ramps and various obstacles	pink	<a href="#">Track Mode [83]</a>
Car passenger mode	Securing the wheelchair as a seat in a vehicle (depending on version)	green or yellow	<a href="#">Car Passenger Mode [86]</a>

**Table 5. Overview of the various operating modes**

It is possible to interrupt the following transitions early by selecting another operating mode while the transition is in progress:

- During the first phase of the transition to drive mode (balancing)
- Transitions out of park mode
- Transitions out of stair mode
- Transitions out of track mode
- Transitions out of elevate mode

The transitions out of drive mode into another operating mode (e.g. park mode or stair mode) cannot be interrupted.



### 5.3. PARK MODE

The wheelchair is powered on and off while in park mode. The wheelchair is stabilised by the main wheels, the support system and the tracks at the front. This mode must always be used when getting in and out of the wheelchair (transfer). When park mode is activated, the joystick can be used to move slowly backwards and forwards. To do this, the wheels lift slightly off the ground.

- Release: stopping the wheelchair and all auxiliary motors
- Pull the joystick: Drive backwards (slowly)
- Push the joystick forward: Drive forwards (slowly)
- Left/right: If the wheelchair was previously driving slowly in park mode, this lowers the wheels back to the ground



#### **Do not descend steps on the support system**

Never descend (even shallow) steps and stairs with the support system extended in park mode! The support system could break due to the violent impact and you could topple backwards and injure yourself. Use track mode or drive mode.



#### **Never get in or out of the wheelchair while in drive mode**

Always use park mode to get in or out of the wheelchair. The weight shifts that occur when getting in and out of the wheelchair when it is in drive mode could cause it to move uncontrollably and may cause injury to you or bystanders.



#### **Driving in park mode on steep inclines is not permitted**

From a certain incline or lateral slope, driving in park mode is only possible forwards and downhill. Otherwise, moving the joystick forward or pulling it back will have no effect on the Scewo BRO.



**Figure 37. Park mode**

### 5.3.1. SELECTING PARK MODE

To activate park mode, proceed with the following:

1. Open the menu.
2. Select the park mode option.
3. The wheelchair will now initiate the transition and extend the tracks. You may have to move the joystick forwards or backwards if the servomotors have to cover a longer distance (see also ???).

### 5.4. ELEVATE MODE (SEAT POSITION)

In park mode, you have the option of raising or lowering the position of the seat. Use the elevate mode for this purpose .



**Do not raise the seat while on an incline**

Do not raise your seating position when you are on an incline. You could topple over. The maximum permissible elevation on uneven ground is restricted automatically for your safety.



**Be aware of crushing hazard**

When adjusting the seat, be careful not to get yourself jammed in anywhere. Particular care should be taken under tables and benches.



**Do not lean out to the side when the seat is raised**

Do not lean sideways out of the wheelchair after you have raised the seat. The wheelchair could topple over sideways.



(a) Raised position



(b) Lowered position

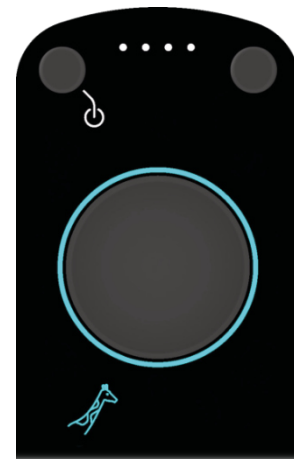

(c) Display on control panel

**Figure 38. Elevation**

### 5.4.1. SELECT ELEVATE MODE

Elevate mode is a sub-mode of park mode. For this reason, you have to switch to park mode first.

1. Switch to park mode.
2. Open the menu again.
3. Select the elevate mode option.
4. You can now use the joystick to adjust the seat height as follows:
  - **Raising:** Pull the joystick back
  - **Lowering:** Push the joystick forward
5. To move slowly forwards and backwards on the tracks in a raised or lowered position, you must switch back to park mode.

## 5.5. DRIVE MODE (BALANCING)

Scewo BRO drives and balances itself on a single axle. By activating drive mode the tracks and support system are raised automatically. In doing so, the unevenness of the surface is automatically compensated for as much as possible. The user should always remain seated in a relaxed position and lean against the back support. The primary steering is not based on shifting the user's weight, but on the integrated joystick.



### Never lean far forward

Leaning forward too far can result in the maximum permissible speed being exceeded. If the maximum speed is exceeded, a loud warning signal is emitted and a visual warning is also displayed on the control panel. If you do not lean back immediately, the wheelchair may go into an emergency stop. This can cause the wheelchair to tip forward and come to such an abrupt stop that the user may be thrown off.



### Calibrate the center of gravity when using drive mode

When using drive mode, it is mandatory to recalibrate the center of gravity before the first drive (see [Calibrating the Center of Gravity \[40\]](#)). **Recalibrating has to be done again in the event of significant changes to the center of gravity, e.g. as a result of an additional load.** If the calibration is not carried out correctly, performance in drive mode may be hazardous and the braking distance may increase significantly.



### Adjust your speed to the conditions around you

Always adjust your speed to the conditions and your abilities! The braking distance may be considerably longer on slopes, slippery surfaces or other environmental conditions. Do not make abrupt steering movements, especially on loose surfaces such as snow or gravel. This may cause the device to go into an emergency shut-down.



### Steep inclines and slopes

When in drive mode, do not go up or down a slope greater than the value specified in the data sheet, otherwise there is a risk of the wheelchair tipping over.



### Changing the center of gravity in drive mode

If something heavy is picked up or loaded into the backpack when the wheelchair is in drive mode (balancing), this can affect the wheelchair's ability to balance itself, move and brake. You need to recalibrate your center of gravity immediately (see Section [Calibrating the Center of Gravity \[40\]](#))

**Keep a safe distance from drop-offs (cliffs)**

In drive mode, always keep a safe distance from drop-off/cliffs (such as stairs) and high steps. Never accelerate sharply towards a drop-off. You could underestimate the braking distance or the wheelchair could move in an unexpected way. There is a danger that you could tumble over the edge and die.

**Automatic emergency stop if the wheelchair moves in a direction other than that specified by the joystick**

The wheelchair may move slowly in the opposite direction to the one you have indicated with the joystick because of insufficient ground clearance or an incorrectly calibrated center of gravity. This could occur for example, if you want to come to a stop on a ramp that is too steep, but the tracks come to rest on the ground at the back. An acoustic warning (beeping) sound will be emitted, which will get increasingly faster. Nothing will happen if you release the joystick during the warning (the wheelchair will still try to stop and may even accelerate slightly). If you continue to pull the joystick in the opposite direction, the wheelchair will go into an emergency shutdown after no more than 5 seconds, come to an abrupt stop and automatically switch to park mode. This can be very bumpy and it may not be possible to switch back to drive mode afterwards (see also [Emergency Shutdown \[62\]](#)). Try to return to park mode and then exit the situation in track mode. If the ground is too uneven or if you cannot manage, call for help.

**Do not use the wheelchair on moving walkways**

Never use the wheelchair on moving walkways (travelators), such as those found in train stations and airports. When moving from the fixed floor to the moving walkway conveyor belt, the wheelchair could tip over at high speeds.

**Always use the pelvic belt while in drive mode**

Not using the pelvic belt or not using it correctly when you are in drive mode could result in serious injuries should the wheelchair go into an emergency shutdown. You could fall out of the wheelchair.

**Never get in or out of the wheelchair while in drive mode**

Always use park mode to get in or out of the wheelchair. The weight shifts that occur when getting in and out of the wheelchair when it is in drive mode could cause it to move uncontrollably and may cause injury to you or bystanders.

**Do not activate drive mode without a seated occupant**

Drive mode must not be activated without somebody sitting in the wheelchair. Since the center of gravity alters significantly if there is nobody sitting in the wheelchair, a stable driving behavior cannot be guaranteed.

**The device or joystick may not be handled by third parties while in drive mode**

Inform third parties about the wheelchair's self-balancing technology and ask them not to touch it or the joystick. The wheelchair can make unintentional movements or go into an emergency shutdown as a result of external interference. If possible, protect the joystick from accidental operation by other people (e.g. at a crowded concert).

**Automatic limitation of the maximum speed**

The maximum speed may be limited automatically by the system on a steep slope or if the battery is low.

### 5.5.1. ACTIVATING DRIVE MODE

**Do not activate drive mode near a drop-off/cliff or an obstacle**

Transition into drive mode only when there is an adequate clearance between you and obstacles or stairs. The wheelchair may move forward or backward if drive mode is activated with a poorly calibrated center of gravity.

1. Open the menu and select the drive mode option.
2. Release the joystick (or position it in the center).
3. The transition will start automatically and the tracks as well as the support system will retract.

**Centre of gravity too far to the front or back**

If the wheelchair cannot find its balance, the balancing mode will stop immediately. The control panel lights up in red. This is mostly due to the user's center of gravity being incorrectly adjusted. However, this can also occur if the wheelchair is affected by an external disturbance during the transition, the floor is too uneven or the occupant moves around too much on the device. To find out how to proceed if this happens, see [Restart After a Balancing Error \[56\]](#).



(a) Side view

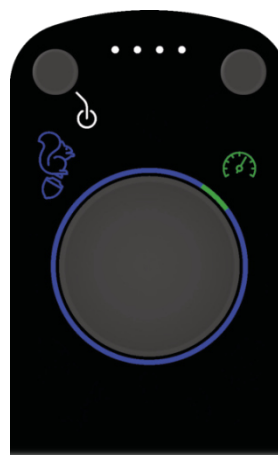

(b) Display on control panel

**Figure 39. Drive mode**

### 5.5.2. RESTART AFTER A BALANCING ERROR

The device monitors a range of critical safety parameters during the balancing mode. In certain circumstances, the wheelchair can enter an emergency shutdown and exit drive mode automatically. The LED ring will then light up in red (see ). Proceed as follows to reactivate drive mode:

1. Select park mode: See [Selecting Park Mode \[50\]](#).
2. The interface lights up with two yellow arrow animations around the touchpad (see also [User Interaction Prompts \[38\]](#)). Move the joystick forwards or backwards to return to park mode. You can interrupt the operation at any time by releasing the joystick.
3. Reactivate drive mode

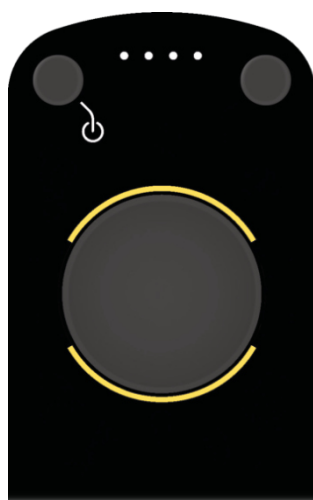
**Figure 40. Control panel indicates that the joystick must be moved forwards or backwards**



**Possible causes of a balancing error**

1. Centre of gravity too far to the front/back (e.g. the wheelchair suddenly rolled forward): Adjust the center of gravity (e.g. change the angle of the back support, remove heavy objects from the backpack).
2. Centre of gravity not calibrated (generally causes poor performance when balancing or braking). Recalibrate the center of gravity (see [Calibrating the Center of Gravity \[40\]](#))
3. Exceeding the speed limit or the maximum inclination that can be driven on.
4. System error

**5.5.3. EXITING DRIVE MODE****Never get in or out of the wheelchair while in drive mode**

Always use park mode to get in or out of the wheelchair. The weight shifts that occur when getting in and out of the wheelchair when it is in drive mode could cause it to move uncontrollably and may cause injury to you or bystanders.

**Caution on uneven or soft ground**

If the ground is uneven, soft or covered with coarse pebbles or other obstacles, the transition may be very jerky and, worst case, the device could tip over (e.g. if one of the wheels of the support system drops into a hole). If possible, avoid exiting drive mode in situations like these, and look for somewhere safer.

**Using the standby button as an emergency stop**

You can return to park mode by pressing the standby button at all times. However, this is a fast shut-down, so the transition can be quite jerky. For this reason, you should only use this method in an emergency (see [Emergency Shutdown \[62\]](#))

1. Select park mode: See [Selecting Park Mode \[50\]](#)
2. The transition will start automatically and the tracks as well as the support system are extended. If you are on a slope, the wheelchair will try to extend the supports to correspond to the slope angle. Nevertheless, a jolt may occur.

**5.5.4. DRIVING IN CONFINED SPACES****Pay attention to the minimum clearance to fixed objects when you are in drive mode**

Failure to maintain the minimum distance may, in certain circumstances, result in damage to the device and cause limbs to become trapped. For this reason, use extra caution in confined spaces or use a different mode to navigate more accurately.

If you are using drive mode in confined spaces, maintain an adequate clearance to fixed obstacles. Due to the way in which the wheelchair self-balances, it can move unexpectedly in the event of weight shifts or collisions, e.g. with other people or fixed objects. The control panel and the foot supports are more exposed than other parts of the wheelchair and can become trapped and damaged if the clearance is too small. Scewo recommends maintaining the following minimum clearance from fixed objects when you are in drive mode:

- To the side: 25 cm
- To the front: 50 cm
- To the back: 25 cm

If the minimum clearance cannot be maintained, use extra caution and, where possible, use park mode to navigate more accurately.

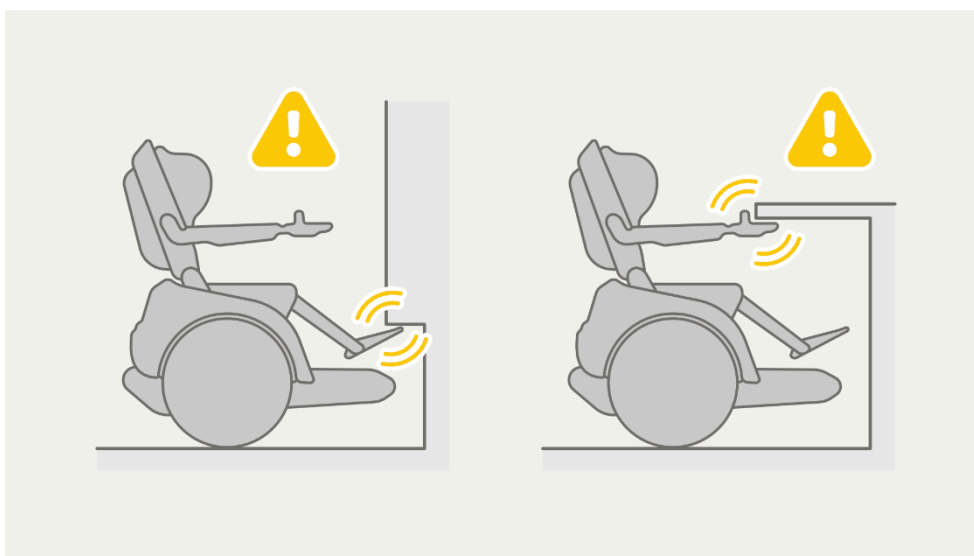

**Figure 41. Pay particular attention to the foot supports and the control panel in confined spaces**

### 5.5.5. TURNS

For safety reasons, you should never take turns at full speed. Before taking a turn, reduce your speed and turn carefully, especially over loose surfaces such as snow or gravel.

### 5.5.6. GOING OVER SMALL CURBS /THRESHOLDS



#### **Always go straight over curbs/thresholds**

Do not go over a threshold on only one wheel, otherwise the wheelchair could topple over sideways. Always go over obstacles at a 90° angle (see [Figure 42](#), "Thresholds may only be crossed at a 90° angle" [59])

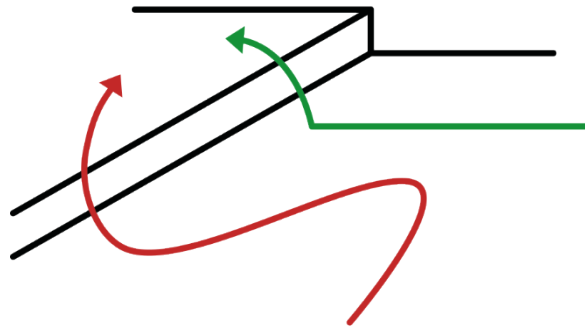

**Figure 42. Thresholds may only be crossed at a 90° angle**



**Make sure you have enough space when going over thresholds**

When crossing thresholds in drive mode, the wheelchair may accelerate sharply for a short time afterwards because of the braking effect exerted by the threshold and then move forwards. It is essential that you practise how to do this before crossing thresholds in narrow spaces (e.g. if a threshold is immediately followed by a wall). If you feel uncomfortable, use track mode. This enables you to cross thresholds in a very controlled manner.



**High thresholds**

If the obstacle is higher than 50 mm, use the stair or track mode to clear it.

**GOING UP AND OVER SMALL THRESHOLDS**

Note the following if you have to go up and over obstacles such as curbs:

1. Find the place where the obstacle is at its lowest point.
2. Approach the obstacle in a straight line and with slight a run-up (approx. 3 km/h).
3. Just before you reach the obstacle. release the joystick briefly. This raises the track tips slightly and increases the ground clearance, see [Figure 43, "Driving up thresholds: Shortly before the main wheel reaches the threshold, the joystick should be briefly released \(brought to the middle position\)." \[59\].](#)
4. Once you have gone over the obstacle, you can accelerate again immediately.
5. When going over an obstacle, it can help, where possible, to use your upper body to get over it (by leaning forward slightly).

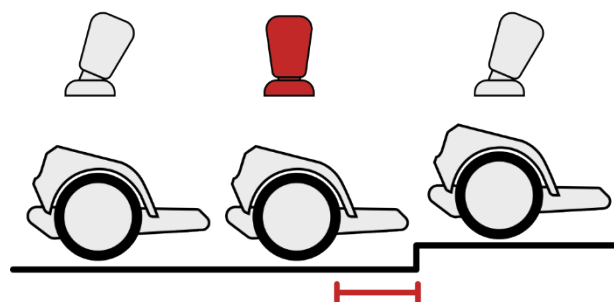

**Figure 43. Driving up thresholds: Shortly before the main wheel reaches the threshold, the joystick should be briefly released (brought to the middle position).**

## GOING DOWN SMALL THRESHOLDS

Note the following if you have to go down obstacles such as curbs:

1. Find the place where the obstacle is at its lowest point.
2. Approach the obstacle slowly and in a straight line.
3. Just before you reach the obstacle. Release the joystick briefly and let the remaining speed carry you down over the obstacle. This ensures maximum ground clearance.
4. Once you have gone over the obstacle, you can accelerate again immediately.
5. When going down over an obstacle, it can help, where possible, to use your upper body to get over it (by leaning backward slightly). This helps to optimise the ground clearance even further.

### 5.5.7. SLOPES



#### **Never lean forward on a downhill slope**

Never lean forward on a downhill slope, especially when braking. Remain seated in the wheelchair or lean back a little (perhaps recline the back support). This ensures the best possible ground clearance and thus the shortest possible braking distance.



#### **On downhill slopes, always move the seat lift back as far as possible**

If you move the seat lift forward, the center of gravity is shifted forward and the braking distance may increase significantly, especially on slopes. For this reason, always move the seat lift as far back as possible before going down a slope.



#### **Automatic lowering of the tracks - reduce speed before going up and down slopes**

When you are driving fast on level ground, Scewo BRO automatically lowers the tracks slightly. If you towards an uphill slope quickly, the tracks can hit the ground at the front and the wheelchair will stop abruptly. For this reason, reduce your speed to below approx. 4 km/h before each incline so that the wheelchair retracts the tracks all the way.



#### **Foot support can collide with the ground**

If you have configured the foot support so that it is very long, it may hit the ground on steep slopes and drag along. This can bring the wheelchair to an abrupt stop. Check that the slope does not exceed 6° and drive up in track mode if necessary. It may also help to lean slightly forward or to raise the angle of the foot support slightly.

**If the tracks touch the ground on uphill slopes**

The tracks may hit the ground at the front on steep uphill slopes and the wheelchair may no longer be able to accelerate or may even start reversing slowly. If this happens, you should turn 90° to the slope and use track mode to ascend the slope. If you still have upper body strength, you can also lean forward slightly. This helps to increase the ground clearance. However, note the maximum allowed angle of 6° / 10.5 % when you are in drive mode.

**When you can no longer brake on a steep slope, trigger an emergency stop**

If you are going too fast on a slope that is too steep and are no longer able to brake, press the standby button immediately to trigger an emergency stop (see Section [Emergency Shutdown \[62\]](#)). Try to avoid this situation at all costs. The wheelchair may topple over.

Descend slopes slowly. Particular care is required when driving down slopes as the wheelchair may pick up speed. When Scewo BRO detects that you are travelling on a slope, the tracks are automatically raised completely. The following maneuvers may cause the wheelchair to overturn or cause injury to the user if the instructions are not followed:

- Never perform an emergency stop on a slope without a good reason.
- Never drive backwards down a slope.
- Do not make sharp turns when going uphill
- Never lean your upper body forward when descending slopes.

**Steep slopes can be overcome in track mode, see [Track Mode \[83\]](#).**

### 5.5.8. DRIVING ON DIFFERENT SURFACES

The wheelchair can be used in drive mode on a variety of surfaces, for example on snow, gravel or sand. However, particular caution is required and the following must be observed:

- Always proceed slowly when travelling on difficult or uneven terrain.
- Do not operate on surfaces where the wheelchair can get stuck (e.g. heavy snow or very soft sand).
- Do not go through shallow areas containing water (more than 5 cm).
- Always use extreme caution on wet surfaces and never accelerate, turn sharply or brake abruptly, as the wheels may lose their grip.

### 5.5.9. DRIVE MODE WITH LOW BATTERY

The battery indicator will flash red when the battery is almost depleted. You will still be able to go a limited distance. The maximum speed will be restricted. If the battery voltage reaches a critical level, the wheelchair automatically switches to park mode and you can no longer activate drive mode.

### 5.5.10. UNEXPECTED MOVEMENTS OF THE WHEELCHAIR

If the wheelchair moves in an unexpected way, immediately release the joystick to stop the wheelchair. In an emergency, use the standby button to stop the wheelchair as quickly as possible.

### 5.5.11. EMERGENCY BRAKE



#### **During emergency braking, lean backwards - never forwards**

In the event of an emergency brake, you should always lean against the back cushion and never forward. Leaning forward increases the braking distance significantly. If you can, try to lean backwards during a braking manoeuvre.

If you have to brake abruptly, you can pull the joystick back or release it (depending on the "Fast Brake" setting, see [Braking Behavior Setting \[41\]](#)). Be aware that the wheelchair will then try to regain its balance with a jerky forward movement. For this reason, only perform this kind of braking manoeuvre in an emergency. You can also briefly press the standby button to trigger emergency braking.

### 5.5.12. EMERGENCY SHUTDOWN



#### **Only use the emergency shutdown in an emergency**

Remember that the emergency stop is very jerky and you may fall out of the wheelchair if the pelvic belt is not fastened. The wheelchair will tip forward onto its tracks and you may need assistance to continue.

In drive mode, the wheelchair monitors various parameters that are essential for safe operation. If the software detects a critical parameter, the emergency shutdown is triggered automatically. The emergency shutdown can also be triggered at any time by the user by pressing the standby button. When you perform an emergency shutdown, the following happens:

1. The wheelchair will shortly recline to the maximum possible angle in order to brake as hard as possible.
2. The tracks and support system simultaneously begin to extend slowly to minimise the tipping angle during shut down.
3. The balancing mechanism is switched off and the wheelchair tips forward onto its tracks.
4. Depending on the speed, the wheelchair may slide on the tracks for a short distance before coming to a standstill.
5. The wheelchair automatically switches to standby mode.

## 5.6. STAIR MODE

The stair mode is used to overcome stairs and other obstacles such as curbs. In stair mode stairs are always ascended backwards and descended forwards. When the stair mode is active, the LED ring on the control panel lights up in purple. [Figure 44, "Stair climbing process" \[63\]](#) shows the different phases of the stair climbing process.

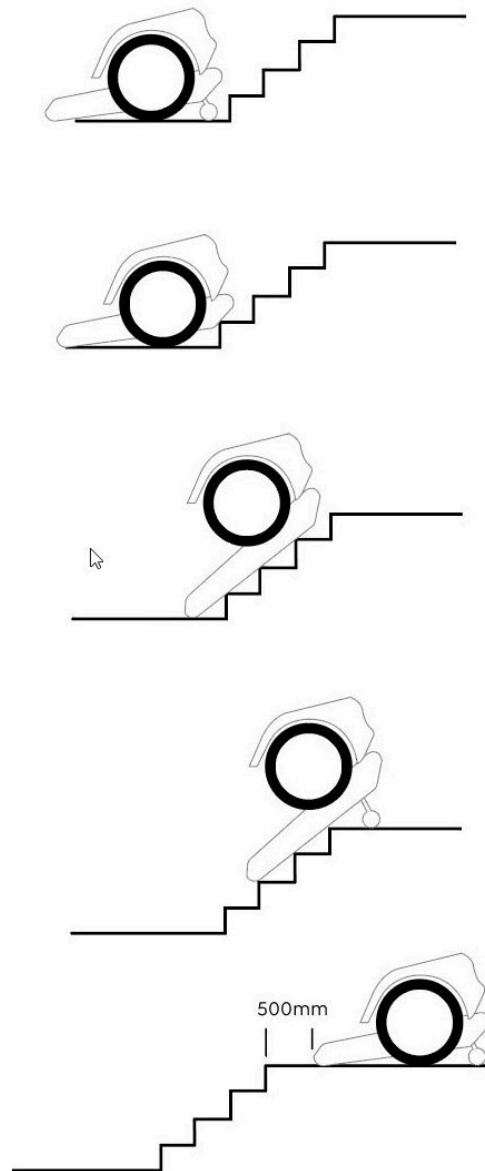

**Figure 44. Stair climbing process**



### **Only drive stairs that are suitable for BRO**

Before climbing stairs, always check if the stairs are suitable for BRO. See in particular the section [Unsuitable Stairs \[73\]](#) to find out which stairs are not allowed to be climbed. Climbing unsuitable stairs may result in serious injuries and even death.



### Descend stairs in stair mode only

Stair mode must always be activated when climbing stairs. The wheelchair does not automatically switch to stair mode before climbing stairs. Approaching the stairs in any other mode than stair mode may be fatal.



### Never switch to stair mode if the tip of the tracks extend beyond the edge of the stairs or step

When switching to stair mode, the tip of the tracks must always be in front of the edge of the stairs or steps.

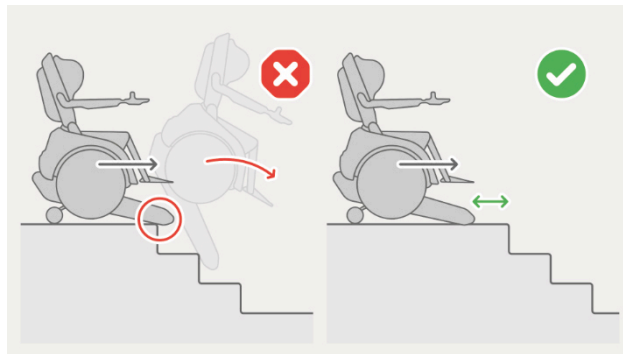

**Figure 45. Only activate stair mode if the tips of the tracks are in front of the top edge of the stairs.**



### Before switching to drive mode: maintain minimum distance to the edge of the stairs

Make sure that the wheelchair has a sufficient **distance of at least 50 centimeters from the edge of the stairs** before switching between stair mode and drive mode. In the following situation you should turn the wheelchair 90° using the maneuvering mode (see section [Maneuvering Mode \[69\]](#)) to ensure that you never accidentally drive down the stairs in drivemode:

- The minimum distance cannot be maintained due to confined space, e.g. if the upper level is too small or an object is blocking your way.

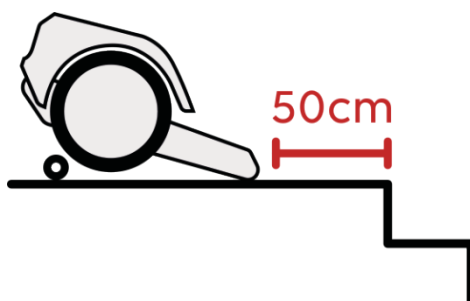

**Figure 46. Only activate the drive or stair mode when a minimal distance of 50 cm to the edge of the stairs is complied to.**





**Always drive straight on stairs**

Always drive straight on the stairs. If the wheelchair informs you that you are at an angle on the stairs, slowly turn back to the center. To do this you have to deflect the joystick sideways.

Remember to also drive slightly forward or backwards while steering so that the tracks do not fall out of their guidance.

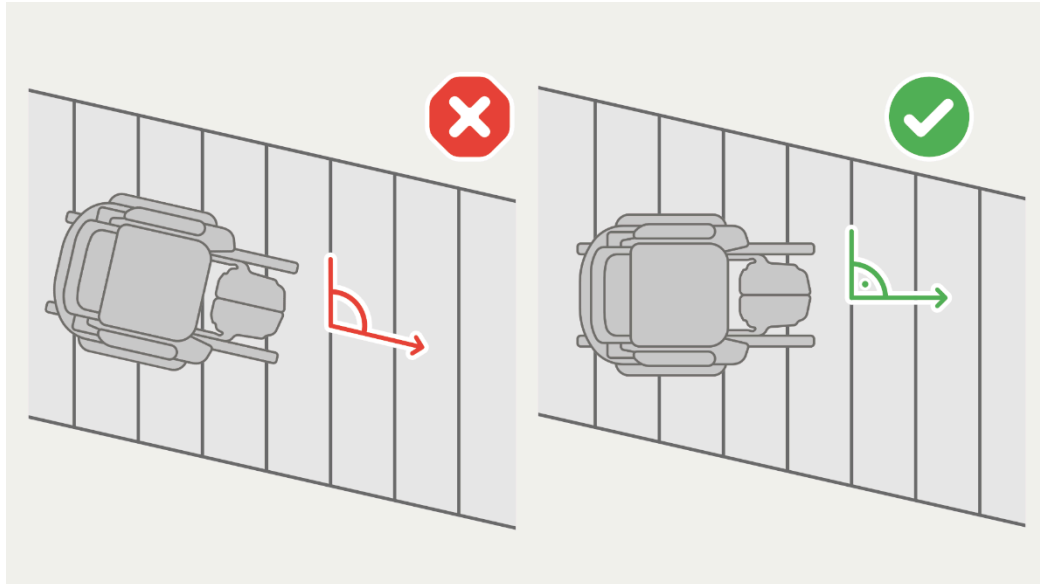

**Figure 47. Always drive straight on stairs**



**Do not make turns on stairs – tracks may fall out of guidance**

Scewo BRO is designed to be used on straight stairs. Don't try to make sharp turns. The lateral forces on the tracks could cause them to fall out of their guidance. You may get stuck on the stairs. If this happens to you, you can try to proceed as outlined in section [Rubber Track Fell out of the Guidance System \[107\]](#).



**Never lean forward or stand up in stair mode**

Never lean forward and do not attempt to stand up or get out of the wheelchair when you are in stair mode. There is a risk that the wheelchair could tip forward and fall down the stairs or that you could slip while getting out of the wheelchair.



**Check the condition of the tracks**

The condition and cleanliness of the tracks are essential for the wheelchair to function safely on stairs. If the tracks are dirty, oily, or wet, you need to clean them with water and a mild detergent before letting them dry. If the tracks are worn down, you need to have them replaced promptly by a Scewo reseller.

**Avoid climbing stairs when the battery is low**

If the battery level is low (battery indicator flashes in red), you should no longer attempt to climb stairs in order to avoid getting stuck unintentionally. Stair mode is always available, therefore you can climb stairs until the battery is fully depleted. However, be aware that the wheelchair will then come to a stop on the stairs and you will have to be evacuated. If possible, it's preferable to go down stairs when the battery level is low, as no power is used during descent.

**Only use stair mode when you are on stairs**

Never switch to another mode when you are on stairs, even if this may be possible due to an error in the system/software. Always select stair mode.

**Tips for climbing stairs**

1. If possible climb wide stairs close to one of the two walls. This allows pedestrians to move past you unhindered.
2. If you are uncertain if the stairs are steeper than the maximum permissible angle, you can measure the inclination using suitable smartphone apps. **If you are unsure whether the stairs are steeper than the maximum permissible angle, do not climb them.**

**5.6.1. SELECTING STAIR MODE**

To select stair mode proceed as follows:

1. Open the menu.
2. Select the stair mode option (purple icon).
3. The wheelchair is now in what is referred to as "stair ready" mode and the sensors, which detect the beginning of the stairs, are active.
4. If you move the joystick to the left or right (blue area on the LED ring), the wheelchair automatically switches to maneuvering mode (see [Maneuvering Mode \[69\]](#)) and pivots on the spot.
5. If you move the joystick forward (purple area of the LED ring), the wheelchair scans if a flight of stairs is approaching and triggers the desired transition at the right moment.

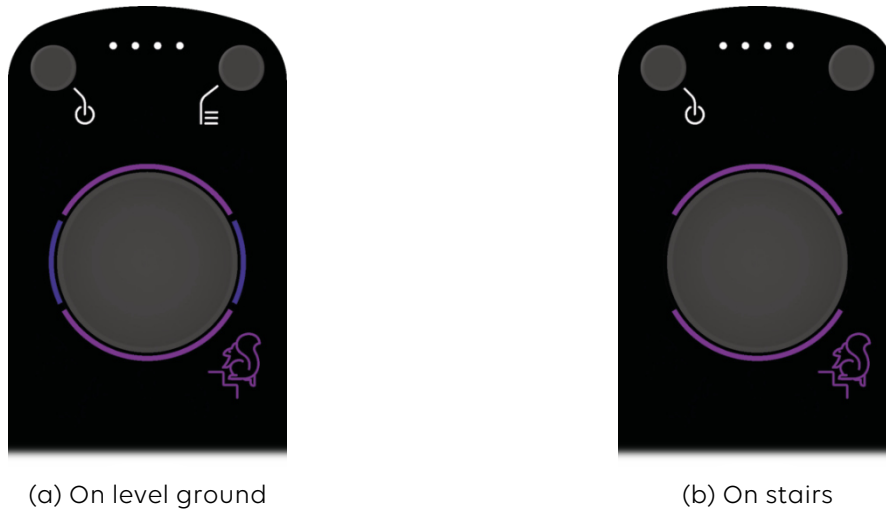

**Figure 48. Stair mode display on control panel**

### TRIGGER END OF STAIRS MANUALLY

You need to continuously monitor if the sensors have correctly detected the end of the stairs. If the end (top or bottom) has not been detected on time, you can manually trigger the transition to level ground while you are still on the stairs :

1. You are in stair mode, on the top or bottom end of the stairs.
2. Open the menu.
3. Select the stair mode option (purple icon).
4. The wheelchair now starts to transition back to level ground and extends the support system to the ground.
5. The information indicator in green shows that the support system is extended.
6. Move the joystick in one of the following directions to complete the transition:
  - **Pull back** → Transition at the top (to the back): Pull the joystick back until the transition to the upper level has been completed.
  - **Push forward (at the top of the stairs)** → Cancel the transition at the top: if you push the joystick forward at the top of the stairs, you can cancel the upper transition and climb the stairs back down again. If you wish to go up again, remember to trigger the end of the stairs manually.
  - **Push forward (at the bottom of the stairs)** → Transition at the bottom (to the front): Push the joystick forward until the transition to the lower level has been completed. The wheelchair may then be in track mode.

## 5.6.2. CLIMBING UP STAIRS



### The user should always monitor the end of the stairs

The sensors that detect the end of the stairs do not work reliably under all circumstances. They were designed to be an auxiliary system. Even if the sensors have detected the end of the stairs, it may be that the system triggers the transition too late and you topple backwards.

**At the latest when the center of the wheel axle has reached the edge of the top step (Figure 49, "When the edge of the top step aligns with the middle of the wheel axle, as seen from above, the transition to the upper level has to be triggered manually at the latest!" [69]), the support system should be extended and the information indicator should light up in green (Figure 50, "The green information indicator shows that the end of the stairs has been detected and the support system has been extended" [69]). If this is not the case, you will have to trigger the transition manually.**

See the section [Triggering end of stairs manually](#) [67] [67].

The following factors can affect the functionality of the sensors:

1. Drops of rain or dirt on the sensors
2. Metal stairs
3. Metal grid stairs
4. Carpeted surface on the upper level
5. Highly reflective or transparent stairs
6. Fixed or movable obstacles or walls near the end (within 1 meter) of the stairs
7. People (e.g. pedestrians, children) or animals close behind the wheelchair
8. Textured or structured surface on the upper level (e.g. paving stones or gravel)
9. Low thresholds (e.g. doorsteps) or cracks in the floor of the upper level

1. Reverse in drive mode until you are approx. 15 cm away from the bottom step. Where possible, use the reverse camera for assistance.
2. Switch to stair mode (see [Selecting Stair Mode](#) [66]).
3. Ensure you are positioned straight in front of the stairs (90° alignment). If not, you can adjust your position using the maneuvering mode (see [Maneuvering Mode](#) [69]).
4. Now you can pull the joystick backwards so that the wheelchair moves back to the bottom step. As soon as he has reaches this point, it will detect the start of the stairs and the wheelchair will use the tracks to ascend them. The angle of the seat adjusts automatically to the incline and remains horizontal.
5. Move the joystick to the left or right to change the alignment of the wheelchair on the stairs. If the maximum angle is exceeded, a sound will be emitted and further turning will be prevented. You should only use this function when necessary, as climbing stairs at an angle could cause the tracks to fall out of its guidance.
6. **When you have reached the end of the stairs, you need to monitor if the sensors have detected it correctly. As soon as the wheelchair has extended the support system, the information indicator will light up in green (see Figure 50, "The green information indicator shows that the end of the stairs has been detected and the support system has been extended" [69]). At the latest, when the edge of the top step is in the middle of the wheel axle, (Figure 49, "When the edge of the top step aligns with the middle of the wheel axle, as seen from above, the transition to the upper level has to be triggered manually at the latest!" [69]) you must trigger the transition manually.**
7. Once the transition to the end of the stairs has been triggered (manually or automatically), the support system will be extended. Continue pulling the joystick backwards until the wheelchair is level on the ground again.

8. If the next set of stairs follows immediately (e.g. at an intermediate landing), it is best to cover the short distance on level ground directly in stair mode on the tracks.
9. Reverse at least 50 cm before switching back to drive mode.

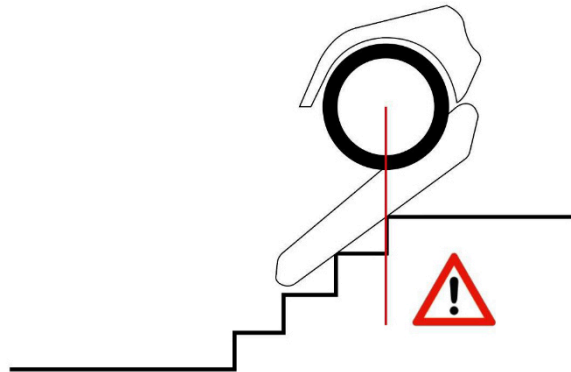

**Figure 49. When the edge of the top step aligns with the middle of the wheel axle, as seen from above, the transition to the upper level has to be triggered manually at the latest!**

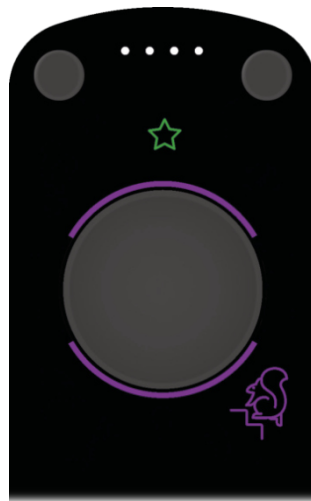

**Figure 50. The green information indicator shows that the end of the stairs has been detected and the support system has been extended**

### 5.6.3. MANEUVERING MODE



**Sensors are not active in maneuvering mode**

When the wheelchair turns in maneuvering mode, no sensors are active that detect obstacles or edges. Pay attention to your surroundings to avoid collisions or tumbling down the stairs. If necessary, repeat steps 2-4 a few times to maneuver safely in confined spaces.



**Turning 90° at the top of stairs in maneuvering mode is recommended**

Use the maneuvering mode to turn 90° on top of the stairs before switching to drive mode. This minimizes the risk of accidentally descending the stairs in drive mode.

Maneuvering mode is automatically activated in stair mode when you are on level ground (not on the stairs). It enables you to turn on narrow landings (e.g. when the stairs continue in a different direction after a landing at a 90° angle) or to adjust your orientation in front of stairs:

1. Make sure you are in stair mode and on level ground. The LED ring of the control panel lights up in purple at the front and back (to climb stairs) and in blue-purple on the left and right.
2. Move the joystick to the left or right → The wheelchair lowers onto the wheels and begins to rotate on the spot in a slightly reclined position.
3. Complete the rotation by releasing the joystick once you are correctly aligned.
4. To move forward or backward again, push the joystick forward or backward → The wheelchair will automatically raise slightly, so that the tracks touch the ground while the main wheels are in the air.
5. You can now tackle the next set of stairs or switch to drive mode.

#### 5.6.4. CLIMBING DOWN STAIRS



##### **Descend stairs in stair mode only**

Stair mode must always be activated when climbing stairs. The wheelchair does not automatically switch to stair mode before climbing stairs. Approaching the stairs in any other mode than stair mode may be fatal.



##### **Always approach stairs straight**

A set of stairs must always be approached in a straight manner (90° angle) and stairs may not be climbed at an angle.

1. Approach the stairs in drive mode until you have a distance of at least 50 cm to the first step.
2. Switch to stair mode (see [Selecting Stair Mode \[66\]](#)) → the LED ring will now light up in purple (see [Selecting Stair Mode \[67\]](#)).
3. If stair mode is active, you can push the joystick forward, and the wheelchair will move to the beginning of the stairs. The first step will then be detected and the wheelchair will descend the stairs on the tracks. The seat will be automatically adjusted to maintain the wheelchair's balance on the incline.

**⚠ Check that the edge of the top step has been detected correctly**

The tracks should lift up once the first step has been detected, and converge to the incline of the stairs. In rare cases, the beginning of the stairs may be detected too early. For this reason, it is essential to ensure that BRO only adjusts to the stairs once you have reached the first step. Examples of such situations include:

- There is a small ledge in front of the top step. The edge of this small ledge may be mistakenly detected as the beginning of the stairs. In such cases, the tracks will not adapt to the stair's incline, and the wheelchair will remain in a track mode on the upper level. If this happens - do not move any further! You should reverse and initiate the stair transition again. You can slowly lower the tip of the tracks over the small ledge in park mode and then switch to stair mode.
- The slope in front of the stairs is too steep. BRO begins the transition prematurely and lifts itself too early without the tip of the tracks having reached the edge of the first step. If this happens, you should reverse a safe distance from the stairs in either stair or park mode, then if necessary cancel the stair mode, and avoid descending these stairs.

4. Move the joystick to the left or right to change the alignment of the wheelchair on the stairs. If the maximum angle is exceeded, a sound will be emitted and further turning will be prevented. You should only use this function when necessary, as climbing stairs at an angle could cause the tracks to fall out of its guidance.
5. Continue driving at the end of the stairs until the wheelchair is completely on the ground. At the end of the stairs, the support system is extended automatically and the green information indicator is displayed. Continue to push the joystick forward until the wheelchair is level on the ground again and the green information indicator disappears. Once this is the case, you can switch back to drive mode.
6. If the next set of stairs follows immediately (e.g. at an intermediate landing), it is best to cover the short distance on level ground directly in stair mode on the tracks.

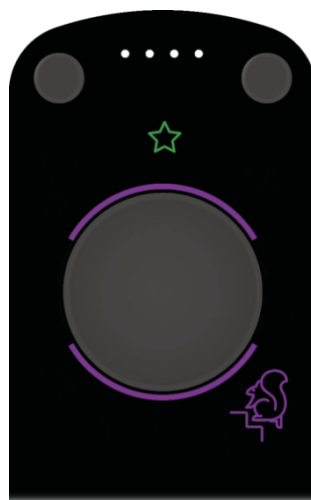

**Figure 51. The green information indicator shows that the end of the stairs has been detected and the support system has been extended. When you continue to move forward, the green information indicator disappears. You are now sufficiently far from the stairs and can switch to drive mode.**

### 5.6.5. SUITABLE STAIRS

Scewo BRO is suitable for most straight and dry stairs. If you are unsure whether a flight of stairs is suitable, always try to climb them from the bottom first, **never from the top!** Once the wheelchair has completely climbed the first two steps (tracks no longer touch the lowest level), shake the wheelchair strongly to test its stability and traction. If you are unable to do this, ask an assistant to give the wheelchair a vigorous shake. If you are still not sure, do **not** climb the stairs.

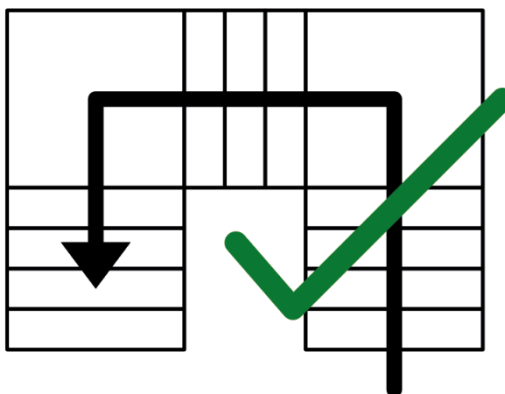

**Figure 52. L-shaped stairs can be climbed easily (for minimum dimensions of corner landings, see [Technical Specifications \[118\]](#)).**

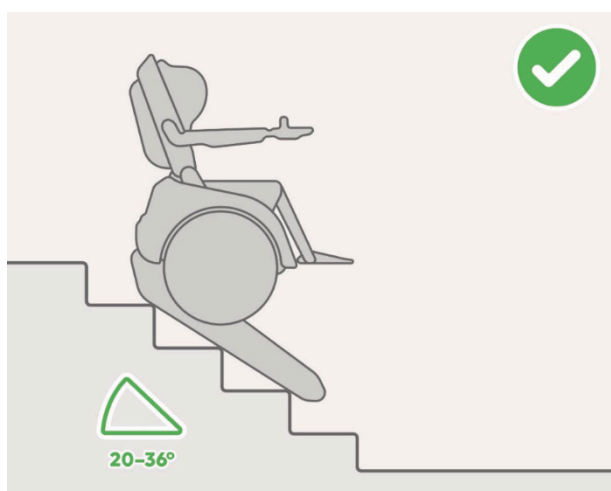

**Figure 53. Stairs with an incline of up to 36° may be climbed.**

 **Consider the maximum stair incline**

Never climb a flight of stairs unless you are certain it is within the maximum permissible incline (see [Technical Specifications \[118\]](#)). If you are not sure, never approach stairs from the top – always from the bottom. Measure the incline with a smartphone app or another measuring device. Subsequently test the traction and stability by moving the wheelchair vigorously after climbing the first two steps.





**Be careful on carpeted stairs**

Some stairs are partially covered with carpet. The carpet is glued or mechanically attached to the supporting surface. Before climbing carpeted stairs, always check that the connection between the carpet and the stairs is strong enough to withstand the increased loads of the stair climber. Otherwise the carpet may detach from the supporting surface causing you to slide down the stairs uncontrollably along with the carpet. This can be potentially life-threatening. You should check this carefully, especially in the case of temporary installations (e.g. at a fair or concert).



**Be aware of the maximum load-bearing capacity of the stairs**

You and your wheelchair weigh significantly more than a single person. For this reason, always check whether the stairs are designed and suited for the total weight of the wheelchair and its occupant. Excessive weight could cause the stairs to collapse.



**Damage to the edges of the stairs is possible**

The stairs may be damaged by the increased load exerted on the edges by the tracks. Therefore, it is essential to check in advance whether the stairs can withstand the load or if protective measures may be necessary (e.g. edge protection on the stairs). To be prepared for all eventualities, we recommend taking out personal liability insurance.

**5.6.6. UNSUITABLE STAIRS**

Scewo BRO is not suitable for the following types of stairs. Refrain from climbing stairs such as:

1. Spiral stairs
2. Moving stairs
3. Damp or wet metal stairs
4. Damp or wet stairs with very rounded edges
5. Stairs covered in snow or ice
6. Stairs with a reduced load capacity of less than 300 kg
7. Stairs with angles that exceed the permissible specifications (see [Technical Specifications \[118\]](#))
8. Stairs featuring steps of varying height and therefore changing incline
9. Stairs featuring an inclined platform that is smaller in length than the "minimum landing size" specified in [Technical Specifications \[118\]](#) both below and above the stairs.

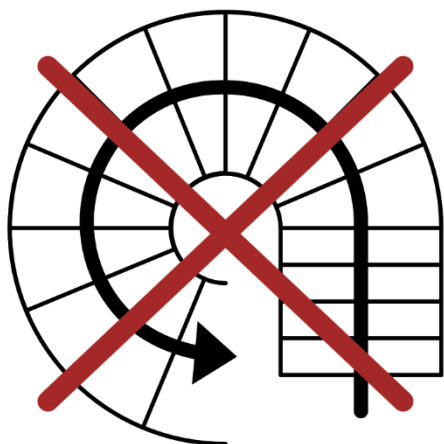

(a) Spiral stairs

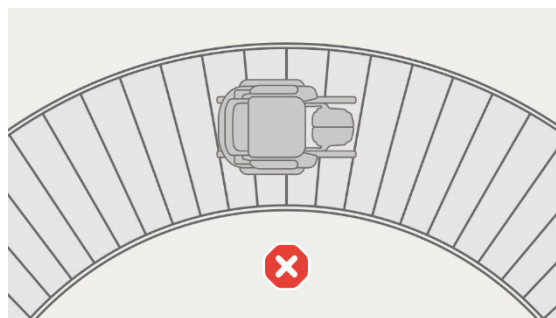

(b) U-shaped stairs

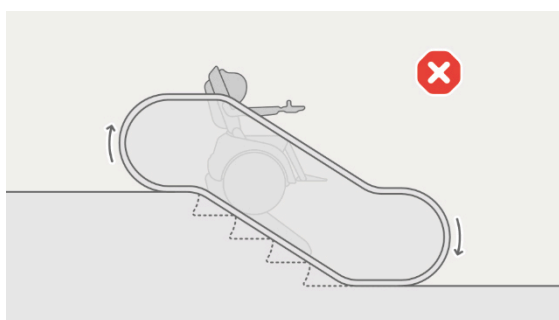

(c) Escalators

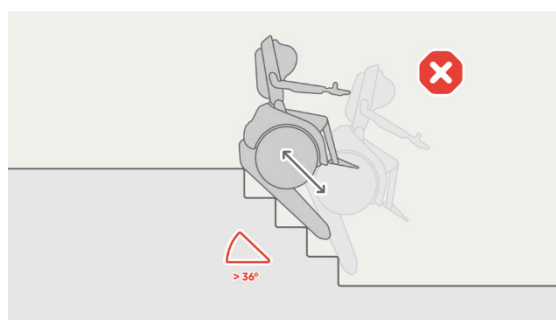

(d) Stairs with an incline exceeding 36°

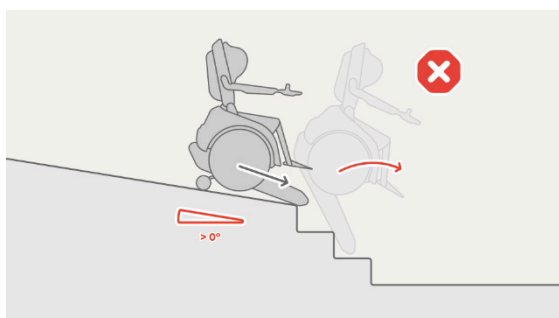

(e) Stairs that do not have a horizontal landing

**Figure 54. Prohibited stairs**



**Do not climb stairs if the tracks or surfaces of the stairs are slippery**

Never climb stairs if you are unsure if the traction of the tracks is sufficient to ascent or descend them safely. You could slide down the stairs at high speed and injure yourself or others. Factors that significantly affect traction include:

1. Damp tracks (e.g. after driving (in drive mode) in rain or snow).
2. Stairs with varying step heights (especially stairs that steepen as you descend them).
3. Dirty tracks (e.g. after driving on gravel, mud or oily ground).
4. Heavily worn tracks
5. Rounded edges of stairs
6. Damp stairs
7. Damp, finely polished stone stairs (e.g. marble or exposed concrete)
8. Damp wooden stairs
9. Heavily worn, rounded stairs
10. Damp metal stairs
11. Carpet
12. Snow or ice on the stairs

**If you are unsure if the surface of the stairs will provide enough traction, do not climb them.**

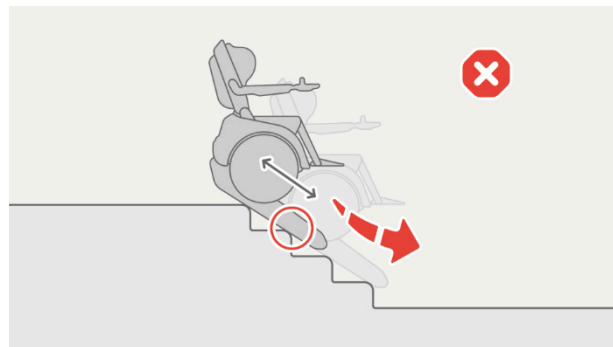
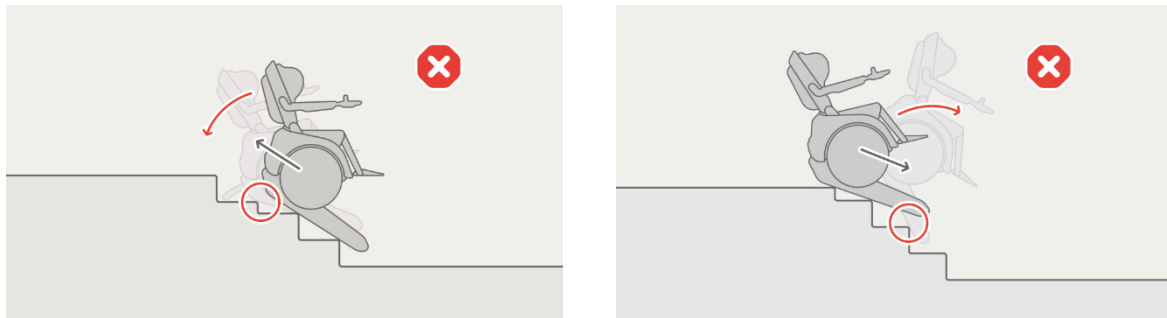

**Figure 55. Do not climb stairs if the tracks or surfaces are slippery**



**Do not climb stairs with varying step heights**

Stairs with varying step heights may be hazardous, especially when descending (**when the stairs steepen** - even if it is the top step, which is not as high as the subsequent ones). Do not climb stairs like these. In the worst case scenario, you could tip forward and injure yourself badly!



(a) Danger of toppling backwards and ejecting the ATS when **ascending**

(b) Danger of toppling forward when **descending**

**Figure 56. Do not use stairs with varying step heights**



**Be careful when descending stairs that have a low bottom step**

Some stairs have a low bottom step (e.g. Fig. 5.19). When descending such stairs, sometimes the end of the stairs might not be detected correctly and the support system extends already on the bottom step. Never descend the bottom step with the support system extended! The support system could break due to the abrupt impact and you could topple backwards onto the stairs and injure yourself. Use the track mode or drive mode to move away from the bottom step.

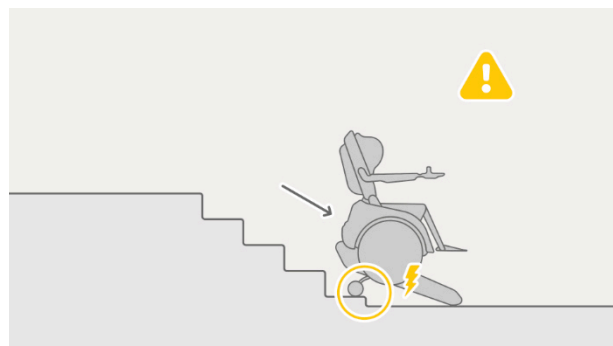

**Figure 57. Stairs with a low last step at the bottom**

**5.6.7. END-OF-STAIR SENSORS**

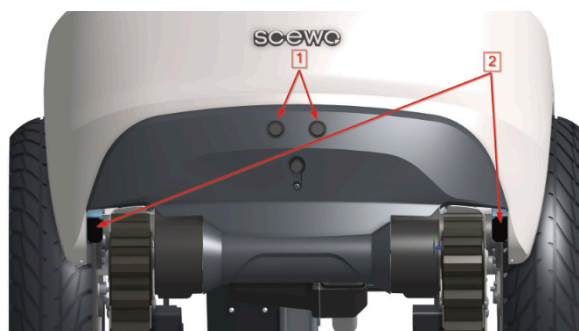

**Figure 58. End-of-stair sensors**



**Be careful with deactivated or defective end-of-stair sensors**

If one or more error indicators flash or light up in red on the control panel when in stair mode (see [Figure 59, "Display of an end-of-stair sensor error on the control panel" \[77\]](#)), one of the sensors is defective or you have deactivated it. Examine the sensor and clean it if necessary. Only disable the sensors if there is absolutely no other way to climb the stairs. If one or more sensors are defective, make sure that you manually trigger the end of stairs when you reach the upper landing and have the sensors repaired as soon as possible.

The wheelchair is equipped with two different types of sensors at the rear, which help to detect the end of a stair. Each sensor type is present twice. The end of the stairs is signaled when one of the four sensors has detected it:

1. **Ultrasonic sensors (long range):** two ultrasonic sensors measure the distance behind you to the next edge.
2. **Infrared sensors (close range):** two distance sensors measure how high the rear of the wheelchair is above the ground.

In case of a sensor malfunction or if the sensors have been deactivated manually, an error message is displayed in red on the control panel when in stair mode (see [Figure 59, "Display of an end-of-stair sensor error on the control panel" \[77\]](#)).

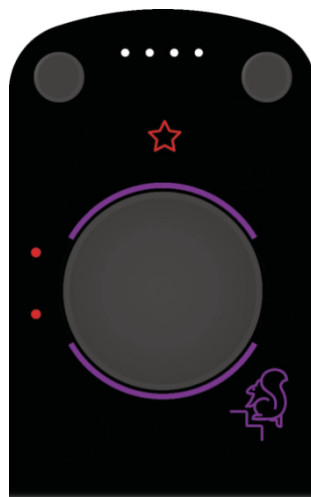

**Figure 59. Display of an end-of-stair sensor error on the control panel**



**Deactivate end-of-stair sensors (not recommended)**

You can disable the sensors in the app (ultrasound and infrared sensors separately). This can be helpful if they are malfunctioning and you still need to ascend a flight of stairs. However, take extra care that the transition to the upper level is triggered on time. Scewo recommends to never disable the sensors. See also [Premature Detection of the End of Stairs \[77\]](#) on how to proceed if the end of the stair is detected prematurely.

**5.6.8. PREMATURE DETECTION OF THE END OF STAIRS**



**Figure 60. Premature detection of the end of stairs in the middle of the stairs**

It is possible that the sensors detect the end of the stairs prematurely causing the support system to extend while you are still on the stairs.(Fig. 5.22 [78] [78]). If you continue to ascend, the sensors detect that another step is approaching and will retract the support system automatically. You will be notified on the control panel and on the app accordingly (see Figure 61, “Automatic detection of another step” [78]). In case this is an error and the support system retracts again by mistake, you can manually trigger the end of the stairs and continue.

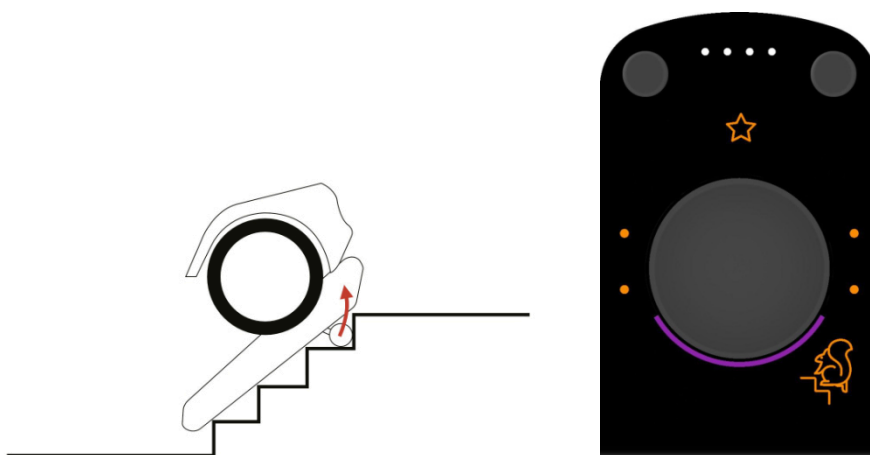

**Figure 61. Automatic detection of another step**

**If this automatic detection of another step fails**, you won't be able to continue climbing the stairs as the support system will be stuck at the next step causing the tracks to spin. Proceed as follows to resolve this situation (**override sensor**):

1. Push the joystick forward again → The support system will retract and the wheelchair will descend slightly.
2. After moving forward slightly, the wheelchair will stop automatically and an audible signal will be played. The LED ring on the control panel displays two orange arrow animations (forward and backward). Move the joystick in the respective direction to do the following:
  - Pull joystick to the back - override the sensor: The wheelchair continues to climb up the stairs without triggering the transition. The previous end of the stairs detection is deleted. After a few seconds the end-of-stair detection restarts and it will be recalculated.
  - Push the joystick forwards: descend stairs. The previously detected end of the stairs will be saved in case you would need to go climb back up again.



**Override sensors carefully**

If you pull the joystick to the back after stopping briefly, the previously detected end of stairs will be deleted. This situation is particularly dangerous if the transition was detected correctly but you wanted to descend the stairs for a short distance and then climb back up again. You could topple over backwards if you fail to trigger the transition manually on time.

**5.6.9. SPECIAL STAIR CLIMBING SITUATIONS**



**Do not attempt to climb high obstacles!**

Stair landings and other obstacles that are higher than the maximum specified obstacle height (see, [Technical Specifications \[118\]](#)), should never be climbed.

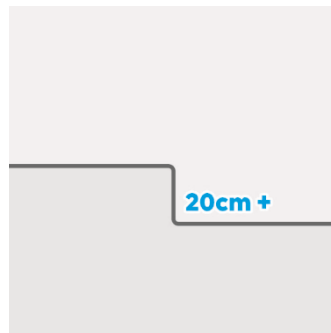

**Figure 62. Obstacles too high for BRO**

**CLIMBING SINGLE STEPS**

You can also climb single steps in stair mode, provided they are not higher than specified in the data sheet under "single step" (see [Technical Specifications \[118\]](#)). To do this, proceed as follows:

**Climbing down a single step**



**Keep a safe distance from the start of the stairs, especially if there is a slope**

If there is a slope in front of the landing, be aware that the braking distance will be longer – maintain a greater distance from the landing.



**Monitor the lower end of the step manually**

With high steps, the detection of the bottom of the step does not always work reliably. It may be that the support system is not extended in time and the wheelchair falls down the step with a jerk. You could injure yourself. The high forces can also damage the wheelchair, requiring it to be repaired. **Therefore, always check whether the bottom of the step has been correctly recognized. If not, manually activate the park position before the rear (slanted) part of the track slips off the step.**

1. In drive mode, drive up to the step, keeping a distance of 50 centimeters
2. Switch to stair mode.
3. If stair mode is active, you can move the joystick forward so that the wheelchair goes all the way to the landing. Sobald er diesen erreicht hat, erkennt er die Kante und der Rollstuhl fährt mit den Raupen die Treppe hinunter. The angle of the seat adjusts automatically to the incline and remains horizontal.
4. Move the joystick to the left or right to change the alignment of the wheelchair on the landing. If the maximum angle is exceeded, a sound will be emitted and you will not be able to turn the wheelchair any further.
5. Observe whether the bottom of the step has been correctly identified. If not, manually activate the park mode before the rear (slanted) part of the track slips off the step. If you cannot select the park mode (e.g. if the step is very high), you can also trigger the end of the stairs manually and then push the joystick forward (see [Trigger end of stairs manually \[67\]](#)).
6. Continue driving at the end of the step until the wheelchair is completely on the ground and the tracks at the back no longer touch the step. As soon as this is the case, you can switch back to drive mode.
7. If the next step follows immediately (e.g. on an intermediate landing), it is best to directly cover the short distance on the landing in stair mode.

**Climbing up a single step:** Proceed as you would with a stair (see [Climbing Up Stairs \[68\]](#) and check that the top of the step has been detected correctly).



**Use track mode for climbing up a single low step**

If climbing up a single, low step in stair mode doesn't work, try doing so in track mode. See section [Track Mode \[83\]](#).

To climb down a single step always use the [Stair mode \[79\]](#).

## CLIMBING UP STAIRS WITH A LOW FIRST STEP

Some stairs have a lower first step. This means that stair mode may not detect the start of the stairs correctly and the tracks may spin freely. If this happens, use track mode and go up the first step backwards. If a certain slope is exceeded, the wheelchair will automatically switch to stair mode.

## GETTING STUCK ON STAIRS

If you get stuck on a flight of stairs – i.e. if the wheelchair suddenly runs out of battery or another problem occurs and the wheelchair can no longer be operated – then proceed as described in [Manual Emergency Operation \(Push Mode\) \[94\]](#). If in doubt, call for help.



## 5.7. ANTI-TIP-SYSTEM (ATS)

The Anti-Tip-System (ATS) is automatically activated if the wheelchair is about to topple over backwards (e.g. because you have forgotten to trigger the end of the stairs or due to a system error in drive mode). Within a fraction of a second, two supports will extend towards the back. An error message appears after the ATS has been ejected. You will not be able to drive on for the time being.



### **Never use the ATS intentionally - it should be used in emergencies only**

The ATS is not designed for frequent use and may suffer damage over time. You should never rely on the function of the end-of-stair sensors and the ATS. Always trigger the upper transition manually if necessary! If the systems fail, you could topple over backwards and injure yourself seriously. Once the ATS has been ejected, you are dependent on the help of other people.



### **Anti-Tip-System error**

The wheelchair's electronics automatically check the functionality of the ATS on a regular basis. If an error is detected, a loud warning sound is emitted at short intervals and an error message is displayed on the control panel. Do not use the wheelchair on stairs and ramps – you could topple over backwards and injure yourself. Have the system checked as soon as possible.



### **If the retraction of the anti-tip system takes a lot of force**

In certain circumstances, the ATS could be damaged by the excessive forces or repeated triggering. If the retraction takes an unexpected amount of force or if there are strange noises, go to your Scewo reseller immediately and have the system checked.



### **Anti-Tip-System not active on flat stairs**

The Anti-Tip-System is not activated on flat stairs, because there is no danger of you toppling over backwards if the top stair transition is activated too late. The wheelchair will jolt backwards significantly but will not topple over. Therefore, you are not dependent on someone else to help you retract the ATS after such an event.

Help from an assistant is needed to retract the system. To do so, proceed as follows:

1. The wheelchair automatically switches to a special mode in order to return to its usual upright position.
2. Pull the joystick back → The wheelchair moves backwards and the support system is extended.
3. This lifts the supports off the ground and reduces the load on them .
4. Ask the assistant helping you to push the locking bolts down and retract the supports by hand (Figure 63, "Retracting the Anti-Tip-System" [82]). The best way to do this is with a little momentum.
5. Now you can proceed to a safe place in park mode before reactivating drive or stair mode.
6. **Never move forward when you are at the top of the stairs!**

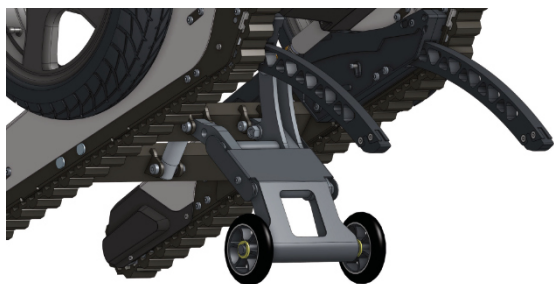

(a) 1 - Starting situation



(b) 2 - Release locking bolt



(c) 3 - Push back the supports by hand

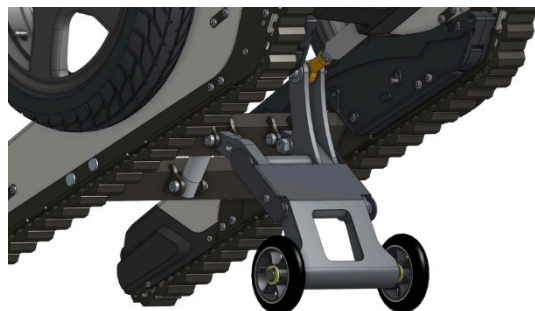

(d) 4 - Anti-Tip-System is operational again

**Figure 63. Retracting the Anti-Tip-System**

## 5.8. TRACK MODE

The tracks can also be used on level ground to overcome obstacles that are not suitable for drive mode. Particularly in the following situations track mode should be used :

- Steep ramps (slopes or inclines)
- For ascending curbs or single steps that cannot be overcome in stair mode (see section [Climbing Single Steps \[79\]](#))
- For approaching stairs from the bottom that have a very low bottom step and the start of the stairs is not correctly detected in stair mode (see section [Climbing up stairs with a low first step \[80\]](#))



### **Never approach a stair or step from above in track mode**

Never approach the top edge of a stair or a step from above in track mode. Scewo BRO may not reliably detect the beginning of the stairs, and you could fall down the stairs. Always use the stair mode for ascending or descending stairs.



### **The user must always trigger the upper end of the ramp or step**

Just like on stairs, when approaching the end of a steep ramp or step, the user must trigger the transition to the top of the stairs themselves. In certain situations, the sensors that can detect the end of the stairs are not always reliable or are deactivated. They were designed to be an auxiliary system only. Therefore, you must ensure at each ramp or step end that the support system are correctly extended and manually trigger the transition if necessary (see [Figure 49, "When the edge of the top step aligns with the middle of the wheel axle, as seen from above, the transition to the upper level has to be triggered manually at the latest!" \[69\]](#)).



### **Always use track mode to ascend slopes in reverse and face forward when descending**

Never drive up an incline facing forward or descend a slope in reverse in track mode. The center of gravity of the device is relatively far back in this mode and you could topple over backwards if you fail to follow this instruction.



### **Do not use tracks on loose ground**

Do not use track mode to operate the wheelchair on loose ground (e.g. sand, gravel or forest floor). Dirt and debris will build up in the tracks and result in significantly increased wear and tear!

### 5.8.1. SELECTING TRACK MODE

The track mode is a sub-mode of the stair mode. For this reason, you have to switch to stair mode first.

1. Switch to stair mode.
2. Open the menu again.
3. Select the track mode option.
4. The wheelchair will now start the transition. You have to move the joystick forwards or backwards so that the servo motors/actuators cover a greater distance (see also [\(a\) Moving joystick forwards or backwards \[39\] \[38\]](#)).



(a) Side view

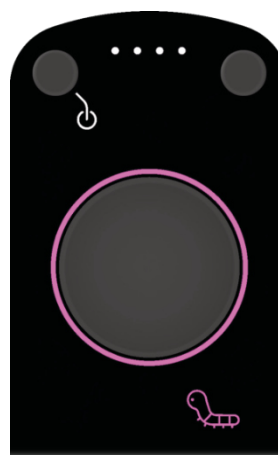

(b) Display on control panel

**Figure 64. Display track mode****Caution when turning on rough ground in track mode**

When you turn on the spot in track mode, the tracks are exposed to very high forces. A very rough surface (e.g. concrete) causes excessive wear and tear and the tracks could even be pulled off at the side. For this reason, use this function with caution and only when absolutely necessary.

**5.8.2. DRIVING ON RAMPS IN TRACK MODE**

Track mode is ideal for ascending and descending steep ramps. Whenever you are unsure if drive mode can be used on an incline, simply switch to track mode. Note the following points when driving on a ramp in track mode:

- Always ascend ramps in reverse and descend them facing forward.
- Make sure that there is enough traction on the ramp, especially if it is wet or covered with ice and snow.
- The wheelchair automatically switches to stair mode if the slope of the ramp exceeds a certain level. You will then be limited to turn.

**5.8.3. SITUATIONS THAT ARE NOT SUITED FOR TRACK MODE**

 **Danger of toppling over backwards when descending thresholds**

The center of gravity of the device is relatively far back in track mode. For this reason, you should never descend a threshold backwards in track mode. Many thresholds begin with an initial rise and then drop down again after a very short distance (e.g. door thresholds). Never drive over them backwards. There is a risk of tipping backward.

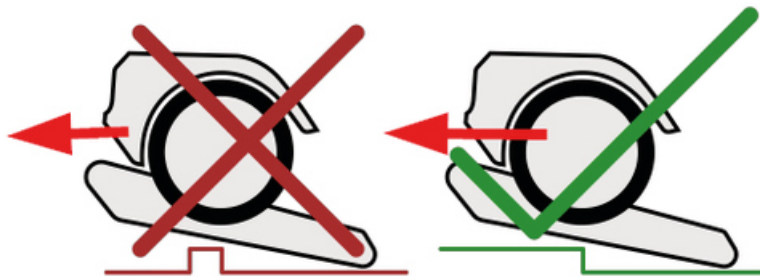

(a) Elevated thresholds backwards

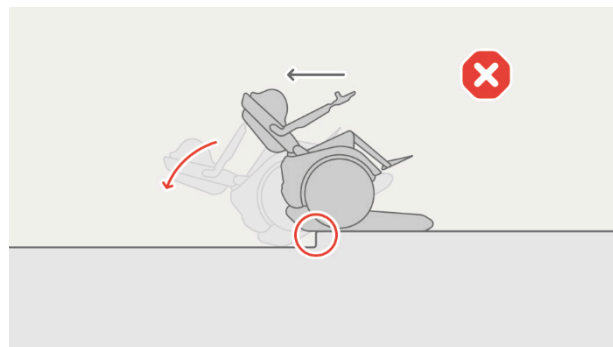

(b) Going down steps backwards

**Figure 65. Unsuitable situations for track mode**

## 5.9. CAR PASSENGER MODE



### **Car Passenger Mode**

This function is not available on your BRO! Your BRO may only be transported as luggage in a vehicle. See also section [Transporting the Wheelchair \[87\]](#).

## 5.10. TRANSPORTING THE WHEELCHAIR

### 5.10.1. TRANSPORTING THE WHEELCHAIR IN THE CAR



#### Approved vehicles

The wheelchair may only be transported in vehicles that are approved and suited for this purpose.



#### Wheelchair not suitable as a passenger seat in a vehicle

During transport, **no** person may remain seated on the wheelchair. You must transfer to a vehicle seat and use the car's seat belt.



### TRANSPORT AS LUGGAGE (WITHOUT PASSENGER)

When loading the wheelchair, please take into account the dimensions of the wheelchair (see [Technical Specifications \[118\]](#)) and the space available in your vehicle. To load and unload the wheelchair into and out of a car, it is recommended to use a ramp designed for this purpose. Please also refer to the operating instructions for the ramp.



#### Space-saving transport

The back support can be folded down to make it easier to transport the wheelchair (see [Folding of the Back Support \[19\]](#)). If necessary, the complete back support can also be removed by means of a quick-release system, see also [Removing the Back Support \[20\]](#).



#### Assistant may be needed

Loading the wheelchair as an item of luggage into a car requires you to get out of the wheelchair. If necessary, have an assistant help you and instruct them on how to load the wheelchair correctly.

To secure the wheelchair correctly in the car, have at least three sets lashing straps (SpanSet) ready:

- 1x small lashing strap to secure the back support
- 2x large lashing straps (minimum holding force 1600N/160kg each) to secure the wheelchair at the front and back

Proceed as follows to get the wheelchair into the car using the ramp:

1. Reverse to the tailgate of the car.
2. Switch to park mode
3. Get out of the BRO
4. Remove any loose objects (e.g. mobile phone) that are attached to the wheelchair
5. If necessary, remove the back cushion (see [Back Cushion \(Accessory\) \[26\]](#))
6. Fold down the back support (see [Folding of the Back Support \[19\]](#)) and secure it with a clamp (see [Figure 66, "Securing the back support to prevent it from unfolding again" \[88\]](#))
7. Position and secure the loading ramp as per the ramp instructions.
8. Switch to track mode or manual mode.
9. Use the joystick, the X-Box (if purchased) or the app (remote control) to manoeuvre the wheelchair into the car. The operating mode has to be changed for this, depending on the car. Seek advice from a reseller or Scewo.
10. If possible, activate the track mode at the end to transport the wheelchair in the car. The highest possible friction between the wheelchair and the floor of the trunk is achieved in track mode (better safety against slipping).
11. Switch the wheelchair off completely using the main switch or press the standby button on the control panel.
12. Secure the wheelchair with at least two approved tie-down lashing straps. We recommend securing the wheelchair as shown in [Figure 67, "Recommended securement of BRO wheelchair V1.0" \[89\]](#).
13. Check that the wheelchair is properly secured and locked into place.



(a) General view



(b) Rear detail



(c) Front detail

**Figure 66. Securing the back support to prevent it from unfolding again**





(a) Securing wheelchair at the front



(b) Front details



(c) Securing wheelchair at the back



(d) Rear details

**Figure 67. Recommended securement of BRO wheelchair V1.0**

### 5.10.2. USAGE AND TRANSPORT OF THE WHEELCHAIR ON PUBLIC TRANSPORT



**Do not use stair or track mode to enter public transport!**

Never use stair or track mode to get on public transport that is not barrier-free! There are many dangers that have not yet been tested. You could get stuck in the gap between the platform and the vehicle or get trapped in the door!

Use the drive mode to enter public transport.



**Never switch to drive mode while you are in a moving vehicle**

Never use drive mode on public transport while the vehicle is moving. The acceleration and braking can cause the wheelchair to move a great deal and you could injure yourself or bystanders. Always use park or track mode while travelling.

**Use lowered park or track mode inside the vehicle**

If possible use park mode in the lowered position (see [Park Mode \[49\]](#)) or track mode to secure the wheelchair as well as possible in order to prevent it from sliding around accidentally while the vehicle is moving.

Scewo BRO can be used on public transport (train, bus, tram) provided the means of transport are barrier-free. Please note the following information:

- Wait on the platform with enough distance (at least 1m) from the edge, preferably in park mode. In this way, pedestrians cannot cause unwanted movement by touching the wheelchair.
- If possible, try to keep the wheelchair parallel to the edge of the platform (so that you cannot fall off if you accelerate unintentionally).
- If possible, ask the train staff to wait until you are safely in park mode before leaving the station.
- Go over the threshold of the foot board in drive mode and with a slight run-up. Watch out for pedestrians. Many people are not aware that you have to take a run-up at the threshold of the foot board.
- Position yourself in the vehicle's direction of travel. You should preferably use the (lowered) park mode. This ensures that the wheelchair slides as little as possible if the vehicle would come to an emergency stop.
- Secure the wheelchair in the vehicle as per the transport operator's instructions and regulations.
- If you wish to turn inside the vehicle (without activating the drive mode), you can use the manoeuvring mode.
- Never use the drive mode while the vehicle is moving.

### 5.10.3. TRANSPORT OF THE WHEELCHAIR ON AN AIRCRAFT

Scewo BRO is approved for transportation as luggage on aircrafts. **The lithium-ion battery is an integral part of the wheelchair and cannot be removed.** You will have to check in your wheelchair and transfer to a special wheelchair provided by the airline. For this reason, you should contact your airline beforehand to discuss the exact procedure.

**See separate quick guide (leaflet) on air transport**

You will find Scewo's recommended and regularly updated procedure for air transport as a separate quick guide available for download in the support section of our website. These instructions for use contain the most important steps only. Ideally, you send the quick guide and the wheelchair's technical specifications to the airline in advance, so that they will know what to expect.

**Always turn off the main switch when wheelchair is inside the aircraft**

The main switch must be turned off at all times. This prevents the wheelchair from moving around inside the cargo area, which, in certain circumstances, could cause a fire.



### Trolley and adhesive tape required

A small trolley (including wheels with brakes) is very useful to enable the ground crew to move the wheelchair easily. For additional safety, the main switch should be secured against being turned on again by covering it with a wide strip of adhesive tape. Ask your airline if they have a trolley and tape or if you need to provide them yourself.

Prior to dropping the wheelchair off, you should prepare it as follows:

1. Use the park mode for air transport
2. Power the wheelchair off completely using the main switch (see [Powering Off \(Storage and Transport\) \[46\]](#))
3. Cover the recessed area around the main switch with the adhesive tape so that any objects that fall down cannot accidentally turn it back on.
4. Ask an assistant to slightly tilt the wheelchair backwards on the rear support system. A second assistant should position the trolley under the tracks' crossbar. The wheelchair can now be easily transported on level ground. If necessary, secure the wheelchair to the trolley with a set of lashing straps.
5. If possible, detach the control panel to avoid damage during transport.
6. Fold the back support down. If possible, protect the back support from being accidentally unfolded again with a lashing strap ([Figure 66, "Securing the back support to prevent it from unfolding again" \[88\]](#)).
7. Scewo recommends securing the wheelchair in the aircraft as shown in [Figure 67, "Recommended securement of BRO wheelchair V1.0" \[89\]](#).



### Always inform your airline

Airlines have different rules for transporting wheelchairs. Please contact the relevant airline for more information and to ensure that the wheelchair can be transported safely.



### Preventing damage to your wheelchair

Wheelchairs are always transported on aircrafts with other items in a confined space. For this reason, it is necessary to take precautionary measures to minimise damage to the wheelchair during transport. Cover the control panel with a soft, shock-absorbing material (foam or similar) or remove it completely. Protect any other components that protrude in a similar way. Fold down components like the back support as much as possible. Tape any loose cables to the seat or covers. **We recommend taking some photos of the wheelchair when you drop it off and pick it up so that you can document any damage that may have occurred during transport.**

## 5.11. CHARGING THE BATTERY

You can see the battery charge level on the control panel (see [Battery Level \[36\]](#)). Follow the instructions below to extend the battery life (lithium-ion batteries):

- Do not wait for the battery to be completely empty until you recharge it. This further damages the battery. The ideal charge level is between 30-75%.
- Only fully charge the battery when necessary. Especially if the wheelchair is to be stored for a longer period of time, it is worth interrupting the charging process (by unplugging the charging cable from the wheelchair) when the charge level is approx. 70%.
- Do not expose the battery to unnecessary heat. Heat accelerates the ageing process of the battery.



### **Never use a different charger**

Only use original Scewo chargers and do not modify them in any way. The wrong charger could destroy the battery and cause a fire.



### **Do not go down a hill or a flight of stairs immediately after the battery has been fully charged**

When descending a slope, the motors function as generators (recuperation). You may overcharge the battery when descending over a long distance, especially if the battery has just been fully charged. To protect the battery from overcharging, the BRO will stop and switch to park mode automatically. The battery indicator briefly flashes in red (see [Error Messages \[108\]](#)). You then have to either switch to track mode to be able to continue your descent or change the route so that you do not continue descending.



### **Charge only while supervising**

Only charge the battery under supervision and never while you are asleep.



### **Ensure that there is sufficient battery charge**

Care should be taken to ensure that the batteries are sufficiently charged before setting off. You should not venture into remote locations if your battery is low.



### **Replace damaged batteries**

If your battery shows signs of mechanical damage (e.g. a dent in the casing, defective plug or cable), stop using Scewo BRO and have the battery replaced immediately by an official reseller.



### **Only charge the battery in a dry environment**

Only charge the battery indoors and in a dust-free, dry environment. Water could damage the charger.

**Do not transport the charger with Scewo BRO**

The charger is not designed to be transported with Scewo BRO. The charger could be damaged by vibrations and other environmental conditions.

The wheelchair charging socket is on the left side. This is how you charge the battery:

1. Turn off the wheelchair and get out of the wheelchair. Ideally, you should switch the BRO's main switch to "off" (less power consumption).
2. Read the separate operating instructions for the charger and familiarise yourself with them.
3. Plug the battery charger into the wall outlet.
4. Turn the charger on.
5. Insert the charger plug into the battery charging socket and make sure that the charging process has started.
6. When charging is complete, the LED on the battery charger will light up in green.

## 5.12. MANUAL EMERGENCY OPERATION (PUSH MODE)

If the wheelchair can no longer be moved (using the motors) due to a serious error or a completely discharged battery, the following options for manual pushing operation are available.



### Resolving the issue

Many errors can be solved by you on site using the correct procedures. Restarting the wheelchair often helps. See also [Error Messages \[108\]](#) for further information on error messages.



### Maintain walking pace

Never push faster than a walking pace. The wheelchair will stop immediately if the brake is applied again. At high speeds, the occupant could be thrown off or the wheelchair could tip over.



### Increased risks during emergency operation, assistant is needed

No sensors or motors are active during the emergency operation. For this reason, only use the emergency operation if no other options are available. Ask a pedestrian or an assistant for help and instruct them so that they can help you deal with the situation safely.



### Sloping terrain

If the wheelchair is on sloping terrain, releasing the brakes together with the high weight (wheelchair and user) can cause unwanted movements of the wheelchair. By releasing the button, the brakes can be applied again at any time.



### Do not pull or push on the head support

The head support is not designed to be used to pull or push the wheelchair. The head support could get bent and someone could be injured by parts that are protruding or have broken off.

### 5.12.1. RELEASING THE MAIN BRAKE



### Only release this brake in an emergency and when the wheelchair is powered off

The brake release button must never be operated when the wheelchair is powered on. Involuntary movements could result in accidents, especially on stairs.

**Limited runtime of manual brake release**

The manual release is powered by a separate battery, so it will work for a limited time even if the main battery is dead. This backup battery will be exhausted after approx. 20-30 minutes and the brakes will lock automatically. Charge the main battery of the Scewo BRO first, so that the backup battery can recharge as well.

During normal operation, the electromechanical brakes are automatically released or applied by the wheelchair's electronics. This automatic feature must be manually overridden for the push mode to work. For this purpose, there is a button (labelled "Brake Release") at the back of the wheelchair beside the main switch with which the brake can be released manually. While the button is pressed, the main motors' brakes unlock and both the wheels and the tracks can be rotated by hand. When the button is released, the brakes are applied again automatically and any movement comes to an abrupt stop. Proceed as follows to release the brake:

1. Power the wheelchair off at the main switch at the back
2. Press the "Brake Release" button

**5.12.2. PUSH MODE ON LEVEL GROUND**

If possible, get out of the wheelchair before it is pushed. This minimises the risk of injury to you and others.

**PUSH MODE WITH RETRACTED TRACKS (DRIVE MODE)**

If an error occurs when the tracks are retracted (drive mode position), the wheelchair will tip forwards or backwards slightly. It can then be pushed out of the way on its main wheels.

1. Power the wheelchair off using the main switch at the back (see [Figure 4, "Labelling of main switch and brake release" \[15\]](#))
2. Ask an assistant to raise the wheelchair with one hand on the backrest so that the wheelchair only stands on the main wheels.
3. The assistant should press the brake release button with their other hand (see [Figure 4, "Labelling of main switch and brake release" \[15\]](#)).
4. The wheelchair can now be moved by applying gentle pressure with one hand on the backrest and with the other hand on the brake release button.

**PUSH MODE WITH EXTENDED TRACKS (PARK MODE)**

If the tracks are extended (park mode position), the wheelchair can be pulled backwards by an assistant.

1. Power the wheelchair off using the main switch at the back (see [Figure 4, "Labelling of main switch and brake release" \[15\]](#))
2. Ask an assistant to pull the wheelchair backwards with both hands on the back support (the brake release button does not need to be pressed).
3. This enables the wheelchair to be moved on the support system wheels.

**Caution on thresholds**

Do not allow yourself to be pulled down over thresholds. The wheelchair could topple over backwards. If going over a threshold cannot be avoided, warn the person assisting you that they may have to support the wheelchair from behind if it tips backwards. If necessary, ask additional people for assistance.

**PUSH MODE WITH EXTENDED TRACKS (TRACK MODE)**

If you are stuck in track mode, it will be extremely difficult to move the wheelchair. Try switching to another mode. If this is not possible, three people are needed to push you:

1. Power the wheelchair off using the main switch at the back (see [Figure 4, "Labelling of main switch and brake release" \[15\]](#))
2. Person 1: Press the brake release button on the back of the wheelchair (see [Figure 4, "Labelling of main switch and brake release" \[15\]](#))
3. Person 2 and 3: turn the main wheels by hand. This way, through the transmission, the tracks are also moved and the wheelchair can be brought to another position or oriented in a different direction.

**5.12.3. PUSH MODE ON STAIRS**

If the wheelchair stops in the middle of stair, it is possible to evacuate the user to the next landing in a controlled manner.

**Risk of pinching due to rotating main wheels**

The wheelchair's main wheels turn during the evacuation. Beware of the danger of getting fingers and hands caught.

**Do not get out of the wheelchair on the stairs**

If possible, please have yourself lowered to the next accessible landing or flat platform before getting out of the wheelchair. The device may be unstable on the stairs and getting out of it may be dangerous because of its high elevation.

**DOWNWARD EVACUATION FROM A STAIR (RECOMMENDED)**

1. Power the wheelchair off using the main switch at the back (see [Figure 4, "Labelling of main switch and brake release" \[15\]](#)).
2. Ask pedestrians who may be below the wheelchair to move away from it. They could be injured.
3. Ask an assistant to press the "Brake Release" button at the back (see [Figure 4, "Labelling of main switch and brake release" \[15\]](#)) very briefly (about half a second) before releasing it again. → This releases the brakes briefly and the wheelchair begins to slowly descend on its tracks.
4. Ask the person assisting you to keep pressing the button repeatedly to enable you to descend slowly until you reach the landing below you. The button must be released immediately if the wheelchair moves too quickly.



5. If necessary, the wheelchair's alignment on the stairs can be altered by braking the left or right wheel (press against the tyre with your hand). The wheelchair can be moved completely onto the next landing by rotating the main wheels forwards. The main wheels act as a transmission so that no great force is necessary.

## UPWARD EVACUATION FROM A STAIR



### **Danger at the top of the stairs**

When arriving at the top of the stairs, the wheelchair must be tilted backwards over the edge and supported by your assistants. Otherwise the wheelchair could tip over. For this reason, Scewo always recommends that the evacuation is carried out by going down the stairs where possible.

If necessary and provided that at least three people can provide assistance, the wheelchair can also be moved up the stairs on its main wheels. The main wheels act as a transmission so that no great force is necessary:

1. Assistant 1 and 2 should stand to the left and right of the wheelchair respectively and block the wheels by holding on to the spokes.
2. Once assistant 1 and 2 are ready, assistant 3 should press the brake release button (see [Figure 4, "Labelling of main switch and brake release" \[15\]](#)). Assistants 1 and 2 will now feel a slight pressure on the wheels.
3. Assistants 1 and 2 can now move the wheelchair up the stairs by rotating the wheels backwards.
4. If one of the assistants gets tired, the process can be interrupted at any point and for as long as necessary by releasing the brake release button. The wheelchair will then simply come to a stop on the stairs.
5. Caution! Once the top of the stairs has been reached, the wheelchair must be guided gently over the edge. Assistant 3 has to prevent the wheelchair from tipping backwards by holding onto the top of the back support.

## EVACUATION FROM A STAIR IF A TRACK HAS FALLEN OUT OF THE GUIDE

If a track has fallen out of the guidance system, you should stop immediately and proceed according to [Rubber Track Fell out of the Guidance System \[107\]](#).

## 5.13. CONNECTING THE APP (AUTHORIZING WI-FI CONNECTION)

To connect to the app, follow the instructions in the app. You have to connect your smartphone to the wheelchair's Wi-Fi hotspot. The app asks for authorization during this process. This is to ensure that only devices authorized by you can connect to your wheelchair. To authorize a connection, do the following:

1. Wait for the app to ask you to authorise the connection.
2. Keep the menu button pressed for at least three seconds until the control panel vibrates and all of the wheelchair's external LED lights flash in yellow.
3. Release the menu button. You should now have a connection.

## 6. ADDITIONAL SAFETY INFORMATION

It is essential to comply with the following when using Scewo BRO.

### 6.1. BASIC NOTES AND INSTRUCTIONS

- Failure to use the device as specified in these instructions (especially drive and stair mode) may result in potentially hazardous situations. Scewo is not liable for the improper use of the device and any damage resulting therefrom.
- Before the device and especially the stair mode can be used, training must have been carried out by Scewo or an official reseller and the exam must be passed. See also section [BRO Certificate \[12\]](#).
- If all of the wheelchair's external position lights light up permanently in red when you are on a flight of stairs, the wheelchair has detected an error with the end-of-stair sensors or the anti-tip system. Only use the wheelchair on the stairs if absolutely necessary and with the greatest caution. Have it checked by a reseller as soon as possible.
- Never go down a flight of stairs in drive mode. Always activate stair mode when using stairs.
- Do not allow anyone who has not been instructed and examined to try out the wheelchair.
- Do not use the wheelchair on spiral staircases or escalators.
- Never use the power wheelchair under the influence of alcohol or other substances that affect your attention or physical and mental capacity.
- Do not use your smartphone or the app while driving the wheelchair. The distraction could cause you to collide with other people or objects or drive down a ledge that is too high.
- Always use the pelvic belt when using the wheelchair.
- If the volume is set to "off", you may not hear certain acoustic alerts. For this reason, you should only turn the volume off when you are not using the wheelchair (e.g. at the theatre).
- The maximum weight must not be exceeded under any circumstances.
- Do not leave children unattended with the wheelchair.
- Do not use the wheelchair to pull objects behind it and do not hang heavy items on the back support.
- Do not continue to use the wheelchair if it has been involved in an accident, submerged in water, exposed to fire or damaged in any other way.
- The wheelchair is equipped with specific safety parameters that limit or inhibit the functions of the wheelchair or prevent the wheelchair from being operated in certain conditions. Do not modify any of these safety parameters.
- If the wheelchair reacts differently than usual or if you suspect that it is faulty, stop the wheelchair and power it off. Contact a Scewo reseller to solve the issue.
- Avoid smoking while in the wheelchair. Even though the fabric used has been tested for flame resistance, there is an increased risk of fire from the heat source and because not all parts of the wheelchair are flame retardant. The fabrics comply with the specifications of EN 1021-1 and EN 1021-2. The filling (padding) complies with the specifications of EN 1021-1. Plastic components comply with UL94 specifications where required.
- The stability tests were carried out using standardized dummies. Stability values may differ in reality.
- The power wheelchair may only be used in the environment for which it is intended (as described in [Intended Purpose \[9\]](#) and [Operating the Wheelchair \[45\]](#)). Do not take the wheelchair into areas with elevated electromagnetic exposure. If the power wheelchair is exposed to excessive electromagnetic radiation which is higher than tested standards ([Product Release \[9\]](#)), its function may be impaired and it may go into an emergency shutdown. In extreme situations, it may become unstable or unmanageable. Conversely, the wheelchair's electronics can also generate

electromagnetic fields, which can cause interference with other devices. This can, among other things, impact your immediate environment and lead to disruption (e.g. certain alarm systems of companies).

- The electromagnetic radiation from portable communication devices (e.g. smartphones) and their antennas can affect how the power wheelchair functions. Do not use these devices within 10 cm of the power wheelchair. Exceptions are the storage options provided (BRO backpack and valuables pouch) and on the smartphone holder on the control panel.
- The power wheelchair has only been tested for immunity to radiation at selected frequencies ranging from 20 MHz to 6 GHz ([Product Release \[9\]](#)). The use in the vicinity of transmitters with other frequencies may result in the wheelchair not functioning properly.

## 6.2. PELVIC BELT

The pelvic belt must be fastened around your lap every time you use the wheelchair. This prevents you from falling out of the wheelchair, for example in the event of a collision. Fasten the pelvic belt as tightly as possible over your lap. A second belt can be worn over your shoulder to provide additional support.



### **Always use the pelvic belt while in drive mode**

Not using the pelvic belt or not using it correctly when you are in drive mode could result in serious injuries should the wheelchair go into an emergency shutdown. You could fall out of the wheelchair.

## 6.3. DRIVE MODE

- Always drive carefully and not too fast, especially on slopes, on turns, or when turning and driving indoors.
- Do not put pressure on the tracks while the wheelchair is in drive mode (balancing). This means that no objects may be placed on them and people may not stand or sit on them.
- Please note the country-specific laws and regulations, especially regarding maximum speed (see also '[Private Ground](#)' function (country-specific) [42]). Germany: In the area of the StVZO, the speed may not be increased above 6km/h. Higher speeds are only permitted in private areas

## 6.4. ADDITIONAL DEVICES

- Never operate vital equipment (e.g. ventilator) or other critical appliances using the built-in USB ports. The ports have built-in safety functions which preventively switch off the connections under certain circumstances (e.g. in the event of overload). No permanent power supply is guaranteed.
- Particular care should be taken when using oxygen near electrical circuits or other flammable materials. Contact the oxygen supplier for information on how to handle oxygen.
- Only use parts or accessories approved by Scewo. The use of unauthorized retrofitted accessories and components may alter the wheelchair in such a way that it becomes unstable or uncontrollable. The product warranty may become void if unapproved parts or accessories are used.

- Connecting unauthorized electrical or electronic devices to the wheelchair's electrical system can damage it, make it uncontrollable or uncontrollable, and also affect the electromagnetic compatibility specified in this manual. This will immediately void the warranty.

## 6.5. SPECIAL SITUATIONS

- Never lift the wheelchair with a crane or similar using the pelvic belt's fixing points. These points are not designed to withstand a load like this and could break. See [Lifting Points \[17\]](#) for the points used to lift the wheelchair.
- The wheelchair may not be used to transport heavy loads or more than one person. It is used exclusively to transport a single seated individual on the surface designed for this purpose.

## 6.6. GETTING ON AND OFF

- Never lean on the control panel. It could snap off and you could injure yourself.
- Ensure that your clothes or other objects do not touch the wheels and other moving parts and cannot get caught.

## 6.7. ENVIRONMENTAL CONDITIONS

- Use the power wheelchair outdoors with great caution when the temperature is below or near freezing. Ice surfaces may have formed, which could lead to loss of traction in drive mode (and thus to an emergency stop) or slipping on the stairs.
- Do not leave the BRO in temperatures below freezing for a long time (e.g. in the car in winter). If the battery freezes, it is not possible to switch to drive mode until the battery has thawed again.
- Do not allow the BRO to remain in temperatures exceeding 40°C for long periods of time (e.g. in full sun in a car in summer). If the battery overheats, you cannot switch to drive mode until the battery has cooled down again.
- On very hot days, the battery can overheat and the device will stop automatically. You can then only continue your journey once the battery has cooled down again. On very hot days, avoid going uphill over long distances or taking long flights of stairs.
- Never go through water that comes up higher than the underside of the tracks. This could damage the electronics and the wheelchair could come to an abrupt stop.
- Switch on the wheelchair lights at dusk and at dawn so that other road users can see you.
- Avoid taking the wheelchair on slippery surfaces (snow or ice, loose surfaces such as gravel or sand) wherever possible. However, if you have to, reduce your speed and proceed with utmost caution.
- Protect the wheelchair from moisture, including rain, snow, mud or splashes of water. Moisture can cause a short circuit and the wheelchair may catch fire, resulting in injury or damage to property. If the wheelchair has been exposed to moisture, do not use it until it is completely dry.
- Replace the cover or joystick protector immediately if it shows signs of cracking or wear. Otherwise moisture can penetrate through to the electronics and cause injuries or damage to property, including fire.
- Surfaces may get very hot under certain circumstances as a result of external heat sources (e.g. sunlight). Check the temperature before touching the surfaces and if necessary let BRO cool down in the shade.

- Adjust the volume of the acoustic alerts to suit ambient noise levels. You might otherwise miss them if it is loud.
- Always adjust your speed to the conditions around you. Thresholds and holes are more difficult to see, especially at dusk or in the dark, potentially leading to an accident. For this reason, always proceed slowly and with particular care in difficult conditions, such as limited visibility, so that you can detect obstacles and avoid them in good time.

## **6.8. TRANSPORT**

- Do not stay in drive mode when travelling in moving vehicles (e.g. train or bus). Always switch to park or track mode before the vehicle takes off.
- Wheelchair accessories that are carried separately or attached to the wheelchair must either be securely attached or removed from it when it is carried in a vehicle or on public transport. Any movable items or accessories that have been removed from the wheelchair must be stowed in the vehicle properly during transport. This is to prevent loose parts or parts that could come loose from injuring the vehicle's occupants while it is moving.

## 7. MAINTENANCE AND REPAIR

### 7.1. MAINTENANCE

You must bring your wheelchair to your reseller or Scewo for a general inspection at least once a year. For the rest of the year, you should check your BRO independently according to the maintenance schedule in [Table 6, "Maintenance schedule" \[102\]](#). Failure to comply with the maintenance measures can result in the expiration of the warranty.

Maintenance step	Frequency
Check the battery level and charge the wheelchair batteries if necessary.	Daily
Check that the control panel is not damaged and that the joystick is working.	Daily
Make sure that all detachable parts are securely fastened.	Daily
Check that the pelvic belt is in working order and is not damaged.	Daily
Check if anything sounds strange and contact your reseller if needed.	Daily
Check that the all rear sensors are clean and not damaged. The sensor icons on the control panel should not light up in red.	Daily
Check the tyre pressure and inflate the tyres if necessary.	Weekly
Check that all lights are clean and in working order.	Weekly
Check that the loudspeaker is working (switch-on sound or press the horn button).	Weekly
Clean the wheelchair and the upholstery/covers.	Monthly
Check the condition of the tracks and have them replaced if necessary.	Monthly
Check that the anti-tip system is working by triggering it manually.	Monthly
Full inspection, safety check and maintenance.	Annually

**Table 6. Maintenance schedule**

### 7.2. WHEELS AND TYRES

In terms of safety, the tyres are a vital component of your wheelchair. They consist of standard Segway parts and there is a variety of profiles available. Like a bicycle, the tyre contains a tube that can be repaired in the event of a flat tyre. Scewo recommends using original equipment to ensure the best possible traction and durability.

If the tyres are worn, you should have them replaced promptly to prevent punctures and slipping.



#### **Do not alter the wheel diameter**

When replacing an entire wheel, always ensure that the diameter is correct and never use larger or smaller wheels. If wheels of a different size are fitted, many of the safety features will not function and serious accidents may occur. Always get in touch with an official Scewo reseller for replacement parts.

**Tighten wheels to correct torque**

Always have the wheels replaced by an authorised Scewo reseller. However, should you mount the wheels yourself, you must be sure to tighten the three wheel bolts to the correct torque. The required torque is **25NM** and is also indicated on the rim. If the wheels are tightened to a torque that is too low, they could become loose during a journey, which could result in a serious accident.

**7.2.1. TYRE PRESSURE**

Before starting any journey, make sure that the tyre pressure is correct. The correct tyre pressure is indicated on the rim and in the data sheet (measured when the tyres are cold). Under-inflated tyres may affect stability and manoeuvrability and result in increased wear. Also, it requires more energy to propel the wheelchair forward, which reduces its range.

**7.3. CLEANING**

Regular cleaning prevents unnecessary wear and damage to the wheelchair. The device should also be cleaned thoroughly before it is used by a new owner. Follow these guidelines when cleaning:

**Power off before cleaning**

Power the wheelchair off before you clean it and make sure that the electronics do not come into direct contact with liquids during cleaning.

**Do not apply oil or grease to the tracks and leave them to dry**

Never use oil-based or greasy cleaning agents on the tracks. This would greatly impair traction on stairs and could potentially lead to the falling down the stairs. After cleaning the tracks with water, always leave them to dry before going up and down stairs.

**7.3.1. METAL SURFACES**

Use a soft cloth or sponge, warm water and mild (non-abrasive) detergent when cleaning (e.g. bicycle cleaner). Use soft wax to remove scuff marks and scratches from semi-matt surfaces and car polish (liquid or paste) on shiny surfaces.

**7.3.2. PLASTICS**

Use a soft cloth, warm water and mild (non-abrasive) detergent when to clean plastic components. Use a soft cloth to dry the surface. Do not use solvents or strong household cleaners - the paint may come off and the warranty may be voided.

### 7.3.3. UPHOLSTERY

Wash down the upholstery with lukewarm water, a mild (non-abrasive) detergent and a soft cloth. Repeat the process for stubborn dirt or stains. Before the surface dries, wipe off any water or soapy water residue with a clean, dry cloth. You will find more information on how to clean the upholstery in the washing instructions affixed to the upholstery.

### 7.3.4. DISINFECTION

The wheelchair may be sprayed and cleaned with tested and approved disinfectants. Follow the manufacturer's instructions and do not allow the disinfectant to dry onto the surfaces. For an up-to-date list of all approved disinfectants, go to [www.rki.de](http://www.rki.de).

### 7.3.5. WHEELS AND TRACKS

It is best to wash the wheels and tracks with a hose outside or a cloth and lukewarm water. After cleaning the tracks with water, always leave them to dry before going up and down stairs. Never use solvents, petrol or similar cleaning agents containing oil.

## 7.4. REPLACING THE MAIN BATTERY

As soon as the performance of the battery decreases and the range of the wheelchair is reduced, the batteries are at the end of their service life. This usually happens after around 1000 charging cycles. The battery needs to be replaced. To do this, contact an official reseller or Scewo directly.



#### **Fire hazard if the battery is not handled correctly**

Do not remove the main battery (lithium-ion) yourself or modify it! If damaged, the battery can explode and cause serious burns.

## 7.5. REPLACING THE BACKUP BATTERY

The backup battery provides the power to release the brakes in push mode (see also [Manual Emergency Operation \(Push Mode\) \[94\]](#)). It is charged automatically by the main battery. If the backup battery is defective and the brake release is not working correctly, contact an official reseller or Scewo directly to have it replaced.

## 7.6. SPARE PARTS

If you need replacement parts, always order them from an official reseller or from Scewo directly. Scewo accepts no liability for damage caused by replacement parts from third party suppliers.



## 7.7. DISPOSAL AND RECYCLING

If you no longer need your wheelchair, please contact an official reseller or Scewo directly to discuss recycling options or arrange proper disposal. Many electronic parts and the batteries can be disposed of as electrical waste.



### **Damaged batteries**

Be careful with damaged batteries. There is a risk of explosion. Never dispose of them in household waste.

## 8. SOFTWARE UPDATES



### **Always update BRO to the latest software as quickly as possible**

Updates may contain safety-related improvements and must therefore be installed as quickly as possible.

Check regularly whether the latest software is installed on your BRO and carry out an update if necessary.



### **Changed behavior after updates**

The driving behavior of the wheelchair may have changed after a software update. It is therefore important to drive very carefully after the update. You can find out what has changed in the respective change log on our website.



### **Update can only be carried out in park mode**

In order for the update to be installed, the wheelchair must be in park mode. Only carry out the update in a safe place and if you are not immediately dependent on your wheelchair afterwards (in the case of an incorrect update, it may take a long time before the update can be reversed or functions are restored).

Software updates can be carried out via the app. To do so, proceed as follows:

1. Switch to park mode in a safe place, preferably at home.
2. Check that the BRO battery is charged to over 20 percent.
3. In the app, open Settings → "BRO Software"
4. Follow the instructions to check for, download and install updates.
5. The installation takes a few minutes, after which the wheelchair will be ready to be used again.

## 9. ERROR MESSAGES AND TROUBLESHOOTING

### 9.1. MALFUNCTIONS

If the wheelchair malfunctions, check the following points before contacting your reseller or Scewo:

- Power the wheelchair off and on again.
- Check that the battery is charged enough.
- Make sure you are in the correct mode.

#### 9.1.1. RUBBER TRACK FELL OUT OF THE GUIDANCE SYSTEM

In certain rare circumstances, the tracks may fall out of their guidance system and begin to strip off. You will most likely hear a loud grinding sound and climbing stairs no longer works. The reasons for this can be:

- Track tension is too low
- Rotating in track mode on ground with very high traction
- Going up or down the stairs at a high skew angle (not straight)
- Strong lateral forces are exerted on the track because of the geometry of the staircase
- Track too worn out



**Only do this in a safe environment – crushing hazard!**

Only carry out the following steps if the situation allows it and you were able to get out of the wheelchair safely. Seek assistance from others if this is not possible. Do not go up or down stairs if the track is not fitted properly. Be careful of your fingers. The track is under tension and you could trap your limbs.



**Always power the wheelchair off if it is tilted or jacked up**

If you have to jack up or tilt the wheelchair in order to rethread the tracks, make sure you power the wheelchair off first and never use the joystick to turn the motors. It could be that a main wheel or track accidentally touches the ground and the wheelchair moves in one direction in a jerky and uncontrolled manner.

Proceed as follows to rethread the track:

1. Stop immediately and do not go up stairs.
2. Try moving the wheelchair in the opposite direction to pull the track back on using the motors. If this doesn't help, proceed as follows (**get off the wheelchair first! An assistant is necessary**):
  - a. If possible, get out of the wheelchair. If not, get someone to help you and together try to get down the stairs to the next landing. You may need to use the brake release to do so (see also [Push Mode on Stairs \[96\]](#)).
  - b. Power the wheelchair off.
  - c. Try to lift up the side of the wheelchair where the track has fallen out of the guidance system slightly so that neither the main wheel nor the track touches the ground (jack up the wheelchair). Often, the easiest way is to tilt the wheelchair slightly to the side by the back support.
  - d. Ask someone to rotate the wheel by hand (turn the wheelchair off and press the brake release). This makes it easier to lift the track back into the guidance system. **Do not use the motors while the wheelchair is jacked up.**
3. Call the technical support if you cannot lift the track back into the guide.
4. If you were able to rethread the track, continue to proceed with caution and contact your reseller to have the track checked as soon as possible.

### 9.1.2. INSUFFICIENT BATTERY RANGE

If you cannot achieve the specified range, this may be for the following reasons:



<i>Battery charging behavior</i>	e.g. numerous aborted battery charges, use of incorrect battery chargers.
<i>Maintenance status</i>	e.g. mechanical deterioration or age-related reduction of battery capacity
<i>Environmental factors</i>	e.g. cold weather, road surface
<i>User behaviour</i>	e.g. frequency of starting (acceleration), frequency of driving up slopes, tyre pressure, load capacity

A larger battery can optionally be purchased. To do this, contact an official reseller or Scewo directly.

## 9.2. ERROR MESSAGES

There are three types of messages which appear for various reasons and need to be fixed: defect, warning and information. While only limited information can be displayed on the control panel by means of the symbols and the LED ring, the app will often display more precise information. The following subsections explain the possible error messages and what to do if they occur.

### 9.2.1. ERROR

Symbol or behavior	Error <sup>a</sup> .	Action
	<p>Unspecified generic error.</p> <p>The wheelchair could not find its balance, which is why the transition to drive mode (balancing) was aborted.</p> <p>The transition to drive mode (balancing) was aborted because the ground is too uneven or sloped.</p> <p>The transition to drive mode (balancing) was aborted because you moved too much.</p>	<p>Try switching to park mode and then continue driving. If that doesn't work, switch the wheelchair off at the main switch at the back, wait at least 30 seconds and then switch BRO on again. If this doesn't help, contact an official reseller or Scewo directly.</p> <p>Select park mode and then try switching to drive mode again. See also <a href="#">Restart After a Balancing Error [56]</a>. If it doesn't work the second time, you can try adjusting the position of the back support or leg supports. The center of gravity may also need to be recalibrated (see <a href="#">Calibrating the Center of Gravity [40]</a>).</p> <p>Select park mode. If possible, use track mode and move to an area with even ground. Try switching to drive mode again.</p> <p>Select park mode and try again. Remain seated in a calm and relaxed manner while switching to drive mode.</p>
	<p>The anti-tip system (ATS) has been activated.</p>	<p>You will require another person to retract the supports. You will find the exact instructions here: <a href="#">Anti-Tip-System (ATS) [81]</a>. Adapt your driving behavior so that the ATS is not needed.</p>

Symbol or behavior	Error <sup>a</sup>	Action
	<p>Possible situations:</p> <ol style="list-style-type: none"> <li>1. Because the wheelchair is not sufficiently charged, it cannot continue driving and therefore switches to park mode.</li> <li>2. Because the wheelchair is not sufficiently charged, it cannot enter drive mode.</li> </ol> <p>Error: There is a problem with the battery. Therefore it is not possible to switch to drive mode. The battery is too cold, too hot, overcharged or has another error. Check the app to see what the exact error is.</p>	<p><b>Battery overcharged:</b> Change the direction of travel and go uphill or continue driving downhill in track mode.</p> <p><b>Battery too hot:</b> Wait until the battery has cooled down sufficiently.</p> <p><b>Battery too cold:</b> Leave the BRO turned on. The residual heat can cause the battery to warm up again. Ideally, you should move the BRO to a warmer place.</p>
<p>The standby button is not working / The wheelchair cannot be powered on.</p>	<p>The wheelchair was not used for more than 24 hours and the main switch was left "on". The battery automatically goes into a "deep sleep" after 24 hours to prevent it from discharging.</p>	<p>Turn off the main switch, wait at least 20 seconds and then turn the main switch on again. The wheelchair should now be working normally again.</p>
<p>The battery is not charging properly after the wheelchair has been left unused and uncharged for a long time. The charging process stops after one hour and does not restart.</p>	<p>If the battery is completely empty and the wheelchair is switched on at the same time, the wheelchair itself requires too much power so that the battery cannot be charged quickly enough. After an hour, the charger then switches to error mode because it could not charge the battery sufficiently (safety function).</p>	<p>Disconnect the charger from the wheelchair and from the power (unplug the charger from the socket). Turn off the main switch of the BRO. Plug in the charger again and wait at least 3 hours before powering the wheelchair back on.</p>
<p>An interface is not properly connected</p>	<p>The wheelchair has detected an electronic defect in the touchpad or joystick.</p>	<p>Contact an official reseller or Scewo.</p>
	<p>The wheelchair has detected an electronic defect in the touchpad or joystick.</p>	<p>For safety reasons you cannot continue driving. Contact an official reseller or Scewo.</p>

Symbol or behavior	Error <sup>a</sup>	Action
	The seat lift motor has an error.	Contact an official reseller or Scewo.
	The support system motor has an error.	<ol style="list-style-type: none"> <li>1. Go to a safe place (e.g. home)</li> <li>2. Press the standby button to exit drive mode</li> <li>3. Contact an official reseller or Scewo.</li> </ol>
	Possible situation: <ol style="list-style-type: none"> <li>1. You are in drive mode and can no longer exit it.</li> </ol>	
	The track motor has an error.	Contact an official reseller or Scewo.
	The track motor has a problem determining its position.	<ol style="list-style-type: none"> <li>1. Get out of BRO</li> <li>2. Activate remote control mode</li> <li>3. Move the seat lift to the lowest position</li> <li>4. Extend the track motor completely</li> <li>5. Exit remote control mode and put BRO into park mode</li> </ol>

<sup>a</sup>if possible, see app for more detailed information



### 9.2.2. WARNINGS



Symbol or behavior	Error / Explanation	Action
	The wheelchair is going too fast in drive mode.	Reduce the speed by releasing the joystick slightly.

Symbol or behavior	Error / Explanation	Action
	<p>Possible situations:</p> <ol style="list-style-type: none"> <li>1. Because the wheelchair is not sufficiently charged, it cannot continue driving and therefore switches to park mode.</li> <li>2. Because the wheelchair is not sufficiently charged, it cannot enter drive mode.</li> </ol>	<p>Charge the wheelchair, before you continue (see <a href="#">Charging the Battery [92]</a>).</p>
	<p>The wheelchair motors are at risk of overheating.</p>	<p>Power the wheelchair off for a while before you continue.</p>
	<p>When you transition to the stairs at the bottom, you can't continue going up backwards.</p> <p>The support system got stuck under the stairs because the transition to climbing the stair climbing was too late.</p>	<p>Go back to the beginning and try again. If it still does not work, you can also try it in track mode.</p>

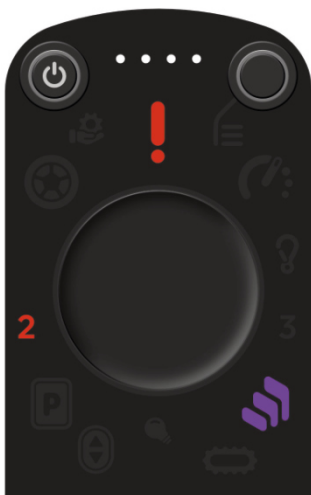



Symbol or behavior	Error / Explanation	Action
	<p>At the transition at the top of the stairs you can't continue going up backwards.</p> <p>At the top of the stairs the BRO is tilted too far forward. For safety reasons, you cannot climb these stairs.</p>	<p>Drive forward again so that the support system retracts and use a different path.</p>
	<p>You want to switch to stair mode at the top of a single step/stair, but it doesn't work. The orange warning indicator appears and the lower half of the ring flashes.</p> <p>The tip of the tracks protrudes over the upper edge of the stairs or step. You cannot switch to stair mode in this position.</p>	<p>Drive back until the symbol disappears or the tip of the tracks no longer protrudes over the edge of the stairs or step.</p>
	<p>In stair mode, the orange warning indicator appears and a segment to the left or right of the ring lights up in orange (in this example, the right).</p> <p>You are too slanted on the stairs (in this case, leaning too much to the right).</p>	<p>Position yourself at a 90 degree angle to the stairs.</p> <p>Push the joystick in the direction in which the orange ring is not lit (in this case to the left).</p>



Symbol or behavior	Error / Explanation	Action
 <p>The image shows a black control panel with a red exclamation mark icon in the center. A red number '1' is positioned to the left of the panel. The panel features a power button at the top left, a directional pad, and a large central touchpad.</p>	<p>On the control panel, the warning indicator and error indicator 1 light up red in stair mode.</p> <p>One or more of the ToF sensors for detecting the end of the stairs are deactivated, malfunctioning or not connected.</p>	<p>Check the electrical connections of the sensors. Switch the sensors back on in the app or by restarting the wheelchair. Check whether the sensors are dirty or damaged. If the problem persists, contact a reseller or Scewo.</p>
 <p>The image shows a black control panel with a red exclamation mark icon in the center. A red number '2' is positioned to the left of the panel. The panel features a power button at the top left, a directional pad, and a large central touchpad.</p>	<p>On the control panel, the warning indicator and error indicator 2 light up red in stair mode.</p> <p>One or more of the ultrasonic sensors for detecting the end of the stairs are deactivated, malfunctioning or not connected.</p>	<p>Check the electrical connections of the sensors. Switch the sensors back on in the app or by restarting the wheelchair. Check whether the sensors are dirty or damaged. If the problem persists, contact a reseller or Scewo.</p>
 <p>The image shows a black control panel with a red exclamation mark icon in the center. Red numbers '1' and '2' are positioned to the left of the panel. The panel features a power button at the top left, a directional pad, and a large central touchpad.</p>	<p>On the control panel, the warning indicator and error indicators 1 and 2 light up red in stair mode. The wheelchair may only move slowly up the stairs.</p> <p>All sensors for detecting the end of the stairs are deactivated, malfunctioning or not connected.</p>	<p>Check the electrical connections of the sensors. Switch the sensors back on in the app or by restarting the wheelchair. Check whether the sensors are dirty or damaged. If the problem persists, contact a reseller or Scewo.</p>

Symbol or behavior	Error / Explanation	Action
	<p>A loud warning tone sounds at regular intervals in stair mode. The warning indicator and error indicator 3 on the control panel light up red in stair mode. The wheelchair might only move slowly up the stairs.</p> <p>The anti-tip system detected an error and was automatically deactivated.</p>	<p>Check the anti-tip system (ATS) electrical connections and reboot the wheelchair. Contact a Scewo or a reseller if the problem persists.</p> <p><b>Do not continue to use the wheelchair on stairs if possible!</b></p>
	<p>The warning indicator flashes continuously in orange.</p> <p>Your BRO runs on an alternate software. This can happen if an error is encountered during the installation of an update, which prevents a successful installation. In this case, an old version will automatically be installed again and this warning will be displayed.</p>	<p>Repeat the BRO software update to ensure that the latest software version is running on your BRO.</p>
	<p>Your BRO is charging right now.</p>	<p>Remove the charging cable to start drive mode.</p>

Symbol or behavior	Error / Explanation	Action
	<p>The ground is too steep to switch to drive mode.</p>	<p>Move to even ground to start drive mode.</p>

### 9.2.3. INFORMATION

Symbol or behavior	Error	Action
	<p>The batteries are almost empty and you can only travel a short distance.</p>	<p>Charge the wheelchair as soon as possible so that you do not get stuck somewhere.</p>
	<p>You have to move the joystick in order to switch to your chosen mode.</p>	<p>Move the joystick in the relevant-direction (see also (a) <a href="#">Move the joystick forwards or backwards [39] [38]</a> )</p>

Symbol or behavior	Error	Action
	<p>The touchpad has no function.</p> <p>The touchpad is disabled.</p>	<p>See <a href="#">Deactivate/Activate Touchpad [39]</a> to reactivate it.</p>
	<p>The joystick must not be moved so that the wheelchair can switch modes.</p>	<p>Release the joystick until the wheelchair has completed the process.</p>

## 10. TECHNICAL SPECIFICATIONS

<b>V1.0</b>	
<b>General</b>	
Basic UDI-DI	-
Wheelchair category in accordance with EN 12184:2014	B
Weight incl. battery (30Ah battery)	160 kg
Total width	685 mm
Min. occupant weight	40 kg
Max. occupant weight (incl. luggage and additional equipment)	120 kg
Minimum dimensions for transport (back support disassembled, LxWxH)	1000 x 685 x 670 mm
Permissible temperature range (battery temperature)	2 - 43°C
<b>Drive mode</b>	
Max. speed	Country-specific: 6 km/h or 10 km/h. <sup>a</sup>  DE: 6 km/h permitted within the area of application of the German Road Traffic Licensing Regulations (StVZO)
Turning diameter (turning on the spot)	1150 mm
Max. gradient (ISO 7176-2)	6° / 10.5 %
Total length	1050 mm
Max. obstacle height (ISO 7176-2)	50 mm
Max. obstacle height at max. speed (ISO 7176-2)	25 mm
Minimum range (measured in actual use), 20 Ah battery	25 km
Minimum range (measured in actual use), 30 Ah battery	35 km
Seat platform height (underside cushion)	600 mm - 630 mm
<b>Stair mode</b>	
Stair climber classification (ISO 7176-28)	Typ E (Self-Standing, Stair-climbing chair)
Permissible gradient	20°-36° / 36.4 %-72.6 %
Max. speed (steps/minute)	30
Max. obstacle height (single step)	200 mm
Spiral staircases	not permitted
Minimum landing size for U-shaped stairs (90° turn)	1150 x 1150 mm
Maximum permissible inclination of the upper or lower landing of a staircase	0°

<b>V1.0</b>		
Minimum width stairs (straight stairs)	760 mm	
Minimum number of steps per single charge (20 Ah battery)	> 1000	
Static stability downhill (ISO 7176-28)	46° / 103 %	
<b>Park mode</b>		
Min. length	1005 mm	
Static stability uphill (ISO 7176-1)	11° / 17.6 %	
Static stability downhill (ISO 7176-1)	35° / 70%	
Static stability sideways (ISO 7176-1)	16° / 28 %	
<b>Track mode</b>		
Min. length	1135 mm	
Seat platform height (underside cushion) / tilting	550 - 690 mm / 19°	
Max. gradient backwards	36° / 72.6%	
Max. gradient forwards	10° / 17,6 %	
Permissible ground surface	Solid ground only (no sand or gravel)	
<b>Seat properties</b>		
Seat width (plate)	450 mm	
Max. seat width cushion	460 mm	
Seat depth (from centre of back cushion plate)	385 - 465 mm (adjustable in 20 mm increments)	
Max. seat depth cushion	510 mm	
Electric seat angle inclination/tilting (in park or track mode only)	-5° to + 19°	
<b>Seat lift</b>	<b>Up</b>	<b>Down</b>
Min. total length wheelchair considering seat height	950 mm	1200 mm
Seat platform height (underside cushion)	870 mm	450 mm
<b>Back Support</b>		
Height (from seat platform under seat cushion)	630 mm	
Electric back support adjustment	15° - 56°	
Back cushion compatibility	- Scewo back cushion (screwed into place) - Sunrise Medical Jay Series (quick-release system)	
Foldable	Yes	
Weight (incl. arm supports)	11kg	
<b>Head support</b>		
Assembly	Mandatory	
Adjustment options	Height and angle	
<b>Arm supports</b>		

<b>V1.0</b>	
Length	365 mm
Joystick length adjustment from center of back cushion	405 - 505 mm
Height (from seat platform under seat cushion)	190 - 310 mm
Distance between arm supports	420 - 500 mm. up to 340 mm possible with adaptation (adjustable in 20 mm increments)
<b>Leg supports</b>	
Length (from seat platform under seat cushion)	320 - 420 mm
Electric leg support adjustment (angle, bow to vertical)	16°- 66°
Foot support angle	mechanically adjustable
Foldable foot supports	Yes, individually
<b>Additional features</b>	
USB charging socket	1x USB-A + 1x USB-C
Charger plug (wheelchair battery)	Magnetic
Rear view camera	Optional
Valuables pouch (in front)	Yes
Backpack	Yes, not detachable
Compatible with Permobil rail system to attach additional upholstery to the seat and foot support	No
<b>Operation</b>	
Smartphone holder	Yes
Control panel with joystick	Yes
Diameter shaft for special joystick attachments	Optional, 1/4 inch (6.35 mm)
Control via buddy buttons	Ja, standby und menu (2x jack connector)
Control panel side	Left or right
Swivelling control panel	Optional
App	Android/iOS
<b>Battery properties</b>	
Chemistry	Lithium-ion
Mounting	Fixed
Nominal voltage	48 V
Capacity (C5)	20 Ah / 30 Ah (optional)
Weight (incl. casing)	7 kg
Maximum charging time (20Ah battery) Capacity (C5)	~5 h
Charger nominal charging current	6 A
Charger nominal voltage	54.6 V DC
Charging cycles	> 1000



<b>V1.0</b>	
Approval for aircraft	Yes, UN 38.3 2017
IATA Wheelchair Classification Code	WCLB (mobility aid with lithium ion batteries)
<b>Tyre properties</b>	
Tyre dimension	80/80-14
Wheel type	Motorbike pneumatic tyre with tube
Recommended tire pressure for maximum comfort (cold tires)	1.5 bar / 22 PSI
Recommended tire pressure for maximum range (cold tires)	2.8 bar / 40 PSI
<b>Transport as a passenger in a car</b>	
Approved for use as a car seat (ISO 7176-19:2008)	No

<sup>a</sup>The maximum permissible speed is programmed for each country prior to delivery.

**Table 7. Data sheet Scewo BRO**

## 11. INDEX

White circle, 38

### A

Accessory

Back cushion, 26

Cup holder, 31

Head support, 27

Lateral thigh supports, 29

Magnetic smartphone holder, 30

Seat cushion, 26

Anti-Tip-System (ATS)

Retract, 81

App

Authorizing, 97

Connecting, 97

ATS, 81

### B

Back cushion, 26

Backup battery, 104

Battery, 104

Charge, 36

Charging, 92

Brake

Release, 94

Brake release, 94

### C

Carpet, 72

Cleaning, 103

### D

Disinfection, 104

Disposal, 105

Drive mode

Activate

Error, 55

Driving over thresholds, 59

Icon, 36

Minimum clearance

Objects, 57

Minimum distance

Stairs, 64

### E

Elevate Mode, 51

Emergency

Emergency shutdown, 54

Evacuation from stairs, 96

Fallen out of their guide, 107

Emergency stop

Button, 35, 46

### I

Ice, 73

### L

Lashing points, 17

LED ring

Orange circle, 38, 39

Red circle, 39

Lifting points, 17, 100

Light, 16

### M

Maintenance, 102

Maneuvering Mode, 69

Moving walkways, 54

### O

Obstacles

Ramps

End, 83

Step

End, 83

Obstacles

Inclines, 83

Ramps, 83

Slopes, 83

Operating mode, 48

Operating modes

Drive mode (balancing), 53

Restart after error, 56

Elevate Mode, 51

Park mode, 49

Push operation, 94

Stair mode, 63

Maneuvering Mode, 69

Unsuitable Stairs, 73

Track mode

Unsuitable situations, 85

Operating modes

Track mode, 83

### P

Pads, 29

Park mode

Selection, 50

Powering off

Storage, 46

Transport, 46

Powering on, 45

Push operation, 94  
 Pushing the wheelchair, 94

**R**

Reset, 47

**S**

Seat  
 Adjust via control panel, 44  
 Select  
 Track mode, 83  
 Settings, 18  
 Arm support  
 Angle, 21  
 Folding, 23  
 Height, 21  
 Length, 22  
 Width, 22  
 Back Support  
 Angle, 19  
 Calibrating the center of gravity, 40  
 Drive mode, 40  
 Fast brake, 41  
 Foot support  
 Angle, 24  
 Folding, 25  
 Head support  
 Angle, 29  
 Height, 29  
 Leg support, 23  
 Angle, 24  
 Length, 23  
 Private ground, 42  
 Seat depth, 25  
 Seat lift  
 Position, 25  
 Snow, 73  
 Spare parts, 104  
 Stair mode, 63  
 Selection, 66

Stair mode  
 Trigger end of stairs, 67  
 Stairs  
 Beginning  
 Detection error, 80  
 Climb down, 70  
 Climb up, 68  
 End, 68  
 Premature detection, 77  
 Sensors, 77  
 Metal, 73  
 Suitable, 71  
 Unsuitable, 73  
 Standby, 46  
 Step  
 Single Step, 79  
 Support system, 13

**T**

Thigh Supports, 29  
 Touchpad  
 Deactivate or activate, 40  
 Track mode, 83  
 Tracks, 65  
 Fallen out of their guide, 107  
 Transport  
 In the car, 87  
 On an aircraft, 90  
 On public transport, 90  
 Removing the back support, 20  
 Turn indicator, 17  
 Turn off, 46

**W**

Warnings, 108  
 Weels/Tyres  
 Pressure, 103  
 Wheels/Tyres  
 Torque, 102

